



**Anzeigelampen**  
**Signallampen**

**Notiz**

# Inhaltsverzeichnis

## table of contents

<b>Glimmlampen</b>	Zwergglimmlampen, Kleinglimmlampen, Signallampen Kleinst- bzw. Piccologlimmlampen	Seite 4
<b>Taschenlampenbirnen</b>	NF-Breitlinse, Spitzlinse Olivenform, Kugelform, Krypton Halogenleuchtampen	Seite 5-7 Seite 7
<b>Kleinröhrenlampen</b>	T9 x 23 mm, Sockel E10 T10 x 28 mm, Sockel E10 T10 x 38 mm, T10 x 50 mm, Sockel E10 T16 x 35 mm, T16 x 43 mm, Sockel E10	Seite 8 Seite 9-11 Seite 12
<b>Kugellampen</b>	G11 x 24mm, E10 G15 x 29mm, E10	Seite 13 Seite 14
<b>Kleinröhrenlampen</b>	T9 x 23 mm, Sockel Ba9s T10 x 28 mm, Sockel Ba9s T10 x 38 mm, T10 x 48 mm, Sockel Ba9s	Seite 15 Seite 16-18 Seite 19
<b>Kugellampen</b>	G11 x 24mm, Ba9s G15 x 29mm, Ba9s	Seite 20 Seite 20
<b>Kleinröhrenlampen</b>	T10 x 28 mm, Sockel Ba10s T13 x 34 mm, Sockel E12 T19 x 48 mm, Sockel E12 T16 x 54 mm, Sockel E12	Seite 21 Seite 22 Seite 22 Seite 22
<b>Röhrenlampen</b>	T14 x 30 mm, Sockel E14 T16 x 35 mm, Sockel E14 T16 x 45 mm, Sockel E14 T16 x 54 mm, Sockel E14 T14 x 30 mm, Sockel Ba15d T16 x 35 mm, Sockel Ba15d T16 x 45 mm, Sockel Ba15d T16 x 54 mm, Sockel Ba15d	Seite 23 Seite 24 Seite 25 Seite 26-27 Seite 28 Seite 29 Seite 30 Seite 31-32
<b>Birnformlampen</b>	22 x 48 mm, Sockel E14, 22 x 48 mm, Ba15d 26 x 57 mm, Sockel E14, 26 x 57 mm, Ba15d	Seite 33 Seite 34
<b>Niedervolt-Tropfenlampen</b>	45 x 80 mm, Sockel E14	Seite 35
<b>Niedervolt-Standardlampen</b>	60 x 105 mm, Sockel E27	Seite 35
<b>Telefonstecklampen</b>	T4,5 4 x 16 mm T4,6 4 x 22 mm T5,5K 5 x 22 mm T5,5 5 x 30 mm T6,5 6 x 44 mm T6,8 6 x 28 mm (PSB) T6,8 6 x 44 mm T6,8 7 x 44 mm, ESB 6x23 mm, BPO 6x43 mm T6,8K 7 x 22 mm, F9 7x28 mm	Seite 36 Seite 37 Seite 38 Seite 39 Seite 40 Seite 40 Seite 41 Seite 42 Seite 43
<b>Telefonlampen</b>	T7 x 20 mm, Sockel Ba7s T7 x 23 mm, Sockel Ba7s	Seite 44 Seite 45

# Inhaltsverzeichnis

## table of contents

<b>Subminiaturlampen</b>	T1 3/4 MG 5,7 x 16mm, S5,7S	Seite 46-47
	T1 3/4 MF 5,7 x 16mm, SX6S	Seite 48-49
	T1 3/4 E 5/8 5,7 x 17,5mm	Seite 50
	T1USA MF (R3/9), T1 French MF (R3/14), MS 2/8, MS 4	Seite 51
	BiPin T1 3,2 x 9,5mm, Pin-Abstand 1,27mm	Seite 52
	BiPin T1 3,2 x 9,5mm, Pin-Abstand 2,54mm	
	BiPin T1 3,2 x 10mm, Pin-Abstand 3,17mm	
	BiPin T1 1/4 4,5 x 16mm, Pin-Abstand 2,54mm	Seite 53
	BiPin T1 1/4 5,7 x 16mm, Pin-Abstand 3,17mm	
	Wedge Base T10 10 x 28mm, Sockel W2,1x9,5d	Seite 54-55
Wedge Base T5 5 x 20mm, Sockel W2,4x6d		
<b>Lampenzieher</b>	für Sockel F9, T4,5 + T4,6, T5,5 + T5,5K, W2 x 4,6d, E10, E14, Ba9s, Ba15d	Seite 55
	T1 3,2 x 6,35mm, freie Stromzuführung	Seite 55
	T1 1/4 4,5 x 11,7mm, freie Stromzuführung	Seite 56
	T1 3/4 5,7 x 13,2mm, freie Stromzuführung	Seite 56
<b>Soffittenlampen</b>	<b>S6</b> 6 x 24mm, 6 x 28mm, 6 x 31mm	Seite 57
	<b>S6</b> 6 x 36mm, 6 x 39mm, <b>S7</b> 8 x 28mm	Seite 58
	<b>S7</b> 8 x 31mm, 8 x 36mm, 8 x 39mm	Seite 59
	<b>S8,5</b> 11 x 39mm, 11 x 43mm	Seite 60
	<b>S8,5</b> 15 x 43mm, <b>SF6</b> 6,4 x 30mm	Seite 61
<b>Lampensockel</b>	Abbildungen gängiger Sockelformen	Seite 62
<b>Lampenwendel</b>	Abbildungen gängiger Wendelformen	Seite 63
<b>Kataloganforderung</b>	Faxvorlage für Kataloganforderung	Seite 64
<b>Bestellformular</b>	Faxvorlage Bestellformular	Seite 65

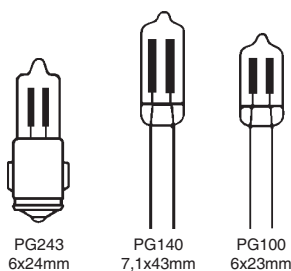
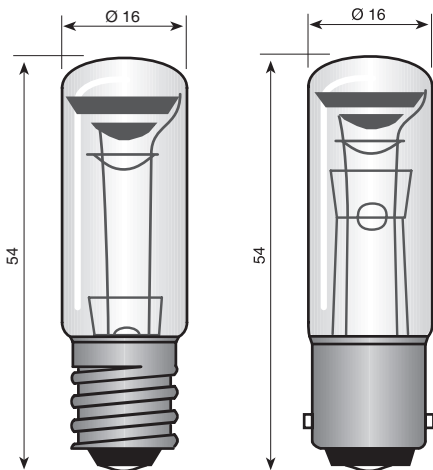
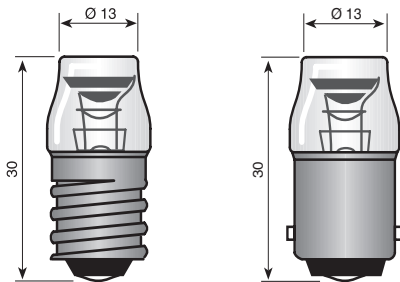
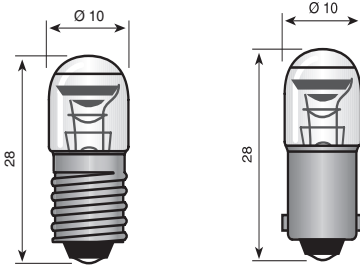
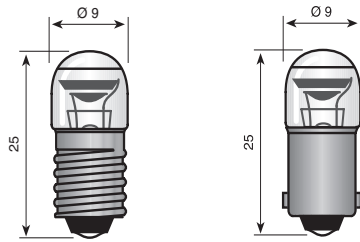

## Zwergglimmlampen

Bestell-Nr. Order-No.	Type Type	Volt Volt	Socket Base
24734	R-LG203	115	BA9s
24744	R-LG234	230	E10
24738	R-LG233	230	BA9s
24750	R-LG274	400	E10
24748	R-LG273	400	BA9s
24706	R-ZG204	115	E10
24704	R-ZG203	115	BA9s
24712	R-ZG234	230	E10
24708	R-ZG233	230	BA9s
24720	R-ZG274	400	E10
24718	R-ZG273	400	BA9s
21003	LG234/3grün	230	E10
21004	LG233/3grün	230	BA9s
21005	ZG234/1rot	230	E10
21006	ZG233/1rot	230	BA9s
21007	ZG234/3grün	230	E10
21021	ZG233/3grün	230	BA9s

## Kleinglimmlampen

24776	R-VG204	115	E14
24780	R-VG234	230	E14
24778	R-VG233	230	BA15d
24784	R-VG274	400	E14
24782	R-VG273	400	BA15d

## Signalglimmlampen

24806	R-SG204	115	E14
24804	R-SG203	115	BA15d
24816	R-SG234	230	E14
24808	R-SG233	230	BA15d
24826	R-SG274	400	E14
24824	R-SG273	400	BA15d

## Kleinst- bzw. Piccologlimmlampen

21014	PG140-16	230	freie
21015	PG100-13	230	Drahtenden
21017	PG243	230	BA7s

# Taschenlampenbirnen

## Lamps for Torches

### NF-Breitlinse , Sockel E10

Bestell-Nr. Order-No.	Type Type	Volt Volt	mA mA
30001		2,2	250
30002		2,2	300
30003		2,2	400
30004		3,3	300
30005		3,7	300

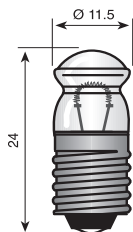

### NF-“brillant“ -OSRAM, Sockel E10

300021	3652	2,2	300
--------	------	-----	-----

### NF-Breitlinse, Prefocus Sockel P13,5s

Bestell-Nr. Order-No.	Type Type	Volt Volt	mA mA
30006		2,2	250
30007		2,2	300
30008		2,2	400
30009		3,7	300

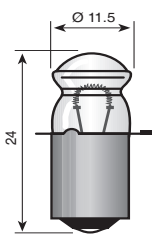

### NF-“brillant“ -OSRAM, Prefocus Sockel P13,5s

300091	3598	3,7	300
--------	------	-----	-----

### Linsenform-Spitzlinse, Sockel E10

Bestell-Nr. Order-No.	Type Type	Volt Volt	mA mA
30010		1,2	220
30011		2,2	180
30012		2,2	250
30013		2,5	200
30014		2,5	300
30015		3,7	300

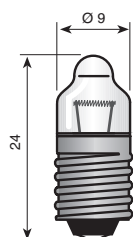

### Linsenform-OSRAM, Sockel E10

300101	3649	1,2	220
300121	3651	2,2	250
300141	3648	2,5	300

# Taschenlampenbirnen

## Lamps for Torches

### Olivenform, Prefocus Sockel P13,5s

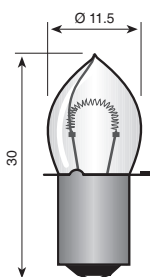

Bestell-Nr. Order-No.	Type	Volt Volt	mA mA
30016	(PR2)	2,4	500
30017	(PR6)	2,5	300
30018	(PR3)	3,6	500
30019	(PR7)	3,7	300
30020		4,8	500
30021	(PR12)	6,0	500
30022	(PR18)	7,2	500
30023	(PR20)	9,0	500

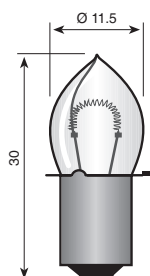

### Olivenform Krypton, Prefocus Sockel P13,5s

24125	KPR 102	2,4	700
24126	KPR 103	3,6	750
24128	KPR 113	4,8	750

### Kugelform, Sockel E10

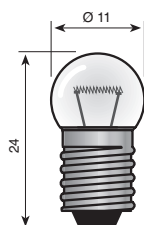

Bestell-Nr. Order-No.	Ausführung Type	Volt Volt	mA mA
30025		2,5	200
30026		2,5	300
30027		3,5	200
30028		3,8	70
<b>30030</b>	<b>rot</b>	<b>3,5</b>	<b>200</b>
30031	gelb	3,5	200
30032	grün	3,5	200
30033	blau	3,5	200

# Taschenlampenbirnen

## Lamps for Torches

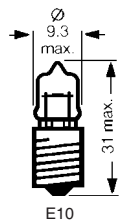
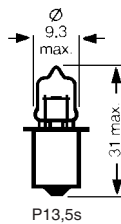
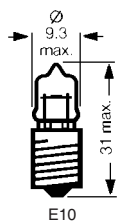
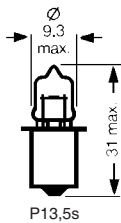
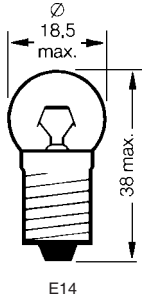
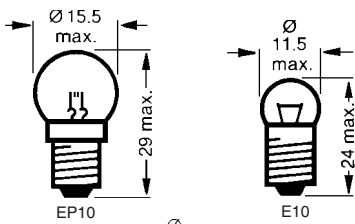

### Scheinwerferlampen (Traffic signalling lamps)

Bestell-Nr. Order-No.	Volt Volt	Watt Watt	Sockel Filament
24081	6	2,4	EP10

### Schlußlichtlampen

240801	6	0,6	E10
--------	---	-----	-----

### Kugelform

24120	24	5	E14
-------	----	---	-----

### Halogenglühlampen, OSRAM (Halogen miniature flashlight lamps)

Bestell-Nr. Order-No.	Type Type	Volt Volt	mA mA	Sockel Filament
241611	6405310	2,8	850	P13,5s
241621	6405710	4,0	500	P13,5s
241631	6405910	4,0	850	P13,5s
241641	6406310	5,2	500	P13,5s
241651	6406510	5,2	850	P13,5s
241661	6407210	6,5	700	P13,5s
241671	6405330	2,8	850	E10
241681	6405730	4,0	500	E10
241691	6405930	4,0	850	E10
241701	6406330	5,2	500	E10
241711	6406530	5,2	850	E10

### Halogenglühlampen (Halogen miniature flashlight lamps)

Bestell-Nr. Order-No.	Volt Volt	mA mA	Sockel Base
24161	2,8	850	P13,5s
24162	4,0	500	P13,5s
24163	4,0	850	P13,5s
24164	5,2	500	P13,5s
24165	5,2	850	P13,5s
24166	6,5	700	P13,5s
24167	2,8	850	E10
24168	4,0	500	E10
24169	4,0	850	E10
24170	5,2	500	E10
24171	5,2	850	E10
24018	12	5 W	BA15s
24019	12	10 W	BA15s

Sockel BA15s ohne Abbildung



# Kleindröhrenlampen

## Miniature lamps

### Kleindröhrenlampen 9x23 mm, Sockel E10

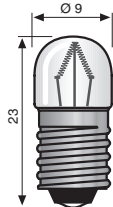

Bestell-Nr. Order-No.	Ausführung Type	Volt Volt	Watt Watt	mA mA	Wendel Filament
30180		2,5	0,75	300	C-2R
30186		4	1	250	C-2R
30132		6	0,3	50	C-2V
30101		6	0,6	100	C-2V
30102		6	1,2	200	C-2V
30190		6	2	333	C-2R
30191		6	3	500	C-2R
30192		12	0,25	20	C-2V
30104		12	0,6	50	C-2V
30105		12	1,2	100	C-2V
30106		12	2	166	C-2V
30107		12	3	250	C-2V
30194		15	0,75	50	C-2V
30195		18	1,8	100	C-2V
30193		24	0,6	25	C-2F
30109		24	1,2	50	C-2F
30198		24	1,5	60	C-2F
30110		24	2	80	C-2F
30111		24	3	125	C-2F
30181		28	1,68	60	C-2F
30184		28	2,2	80	C-2F
30197		30	1	33	C-2F
30199		30	1,2	40	C-2F
30113		30	1,5	50	C-2F
30114		30	2,1	70	C-2F
30187		30	2,4	80	C-2F
30115		30	3	100	C-2F
30117		36	2	55	C-2F
30200		36	3	83	C-2F
30112		42	2	48	C-2F
30116		48	1	20	C-2F
30118		48	1,2	25	C-2F
30119		48	2	40	C-2F
30120		48	3	60	C-2F
30122		60	1,2	20	C-2F
30123		60	2,1	35	C-2F
30124		60	2,4	40	C-2F
30097		60	3	50	C-2F
30121		70	3	43	CC-2F
32002		80	1,6	20	C-3A
30130		130	2,6	20	C-5A
30131		220 V	3	14	CC-6A

# Kleinröhrenlampen

## Miniature lamps

### Röhrenlampen 10x28 mm, Sockel E10

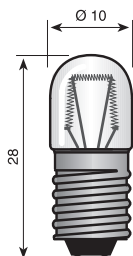

Bestell-Nr. Order-No.	Ausführung Type	Volt Volt	Watt Watt	mA mA	Wendel Filament
30501		1,5	0,75	500	C-2R
30502		2,5	0,5	200	C-2R
30296		2,5	0,75	300	C-2R
30543		2,5	1,25	500	C-2R
30555		2,5	2,5	1000	C-2R
30503		3,5	0,7	200	C-2R
30505		3,5	2,4	700	C-2R
30506		3,8	0,3	70	C-2R
30445		4	1	250	C-2R
30202		4	1,2	300	C-2R
30448		4	2	500	C-2R
30479		6	0,3	50	C-2V
30508		6	0,36	60	C-2V
30509		6	0,45	75	C-2R
30510		6	0,6	100	C-2V
30511		6	0,7	120	C-2R
34204		6	1,1	180	C-2V
30203		6	1,2	200	C-2V
30204		6	2	333	C-2R
30205		6	3	500	C-2R
30512		6	4,2	700	C-2R
30513		6	5	830	C-2R
30514		6	6	1000	C-2R
30515		6,3	0,63	100	C-2V
30516		6,3	1,1	150	C-2V
30504		6,3	1,6	250	C-2R
30206		6,3	2	300	C-2R
30517		6,3	2,8	450	C-2R
30208		7	0,7	100	C-2V
30209		7	2,1	300	C-2R
30519		8	0,8	100	C-2V
30523		8	1,2	150	C-2V
30526		8	2,4	300	C-2V
30351		8	3	375	C-2V
30210		10	0,5	50	C-2V
30211		10	2	200	C-2V
30527		12	0,25	20	C-2V
30212		12	0,6	50	C-2V
30213		12	1,2	100	C-2V
30214		12	1,4	120	C-2V
30215		12	2	165	C-2V
30529		12	2,2	183	C-2V

# Kleinröhrenlampen

## Miniature lamps

### Röhrenlampen 10x28 mm, Sockel E10

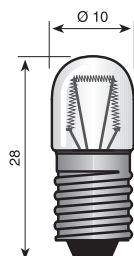

Bestell-Nr. Order-No.	Ausführung Type	Volt Volt	Watt Watt	mA mA	Wendel Filament
30522		12	2,4	200	C-2V
30216		12	3	250	C-2R
30498		12	5	415	C-2R
30530		14	1,1	80	C-2V
30531		14	1,4	100	C-2V
30533		14	2,8	200	C-2V
30534		15	0,75	50	C-2F
30500		15	3	200	C-2V
30546		18	0,36	20	C-2V
30218		18	1,8	100	C-2V
30549		18	2	110	C-2V
30556		18	3	170	C-2V
30219		24	0,6	25	C-2F
30558		24	1	40	C-2F
30220		24	1,2	50	C-2F
30561		24	1,5	60	C-2F
30221		24	2	80	C-2F
30578		24	2,4	100	C-2F
30222		24	3	125	C-2F
34249		24	4	165	C-2F
30223		24	5	210	C-2F
30588		27	2	75	C-2F
30591		28	1,1	40	C-2F
32012		28	1,4	50	C-2F
32014		28	2	70	C-2F
32016		28	2,8	100	C-2F
32017		28	4,8	170	C-2F
30532		30	1,2	40	C-2F
30224		30	1,5	50	C-2F
30225		30	2,1	70	C-2F
30231		30	2,4	80	C-2F
30226		30	3	100	C-2F
30227		30	5	165	C-2F
30580		36	1,2	33	C-2F
30581		36	1,8	50	C-2F
30229		36	2	55	C-2F
30230		36	3	85	C-2F
32019		42	2	45	C-2F
34253		42	3	70	C-2F
34250		42	5	120	C-2F
30542		48	1	20	C-2F
34251		48	2	40	C-2F

# Kleinröhrenlampen

## Miniature lamps

### Röhrenlampen 10x28 mm, Sockel E10

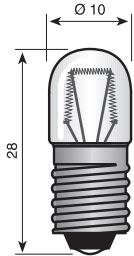

Bestell-Nr. Order-No.	Ausführung Type	Volt Volt	Watt Watt	mA mA	Wendel Filament
30233		48	2,4	50	C-2F
30234		48	3	60	C-2F
34252		48	4	80	C-2F
30544		48	5	105	C-2F
34259		52	3	60	C-2F
30235		60	1,2	20	C-2F
34266		60	1,8	30	C-2F
30236		60	2	33	C-2F
30237		60	2,4	40	C-2F
30238		60	3	50	C-2F
32010		60	4	70	C-2F
132011		60	5	85	C-2F
30239		70	1,4	20	C-2F
32015		80	3,2	40	C-3A
34270		85	3	35	C-3A
34271		110	3	27	C-5A
34274		130	2	15	C-5A
34280		130	2	15	CC-6A
30241		130	2,6	20	C-5A
30243		160	3,2	20	CC-6A
30284		220	2	9	CC-7A
30242		220-240	3-4	14	C-7A
30247		220	5	23	CC-6A
34246		230	5	22	CC-6A
34247		240	2,4	10	CC-7A
34248		240	3	12	CC-7A

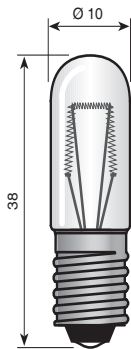

### Röhrenlampen 10x38 mm, Sockel E10

Bestell-Nr. Order-No.	Ausführung Type	Volt Volt	Watt Watt	mA mA	Wendel Filament
34310		30	3	100	C-2F
34311		48	2,8	60	C-2F
34312		60	3	50	C-2F
34313		60	5	85	C-2F
34314		130	4	30	C-5A
34315		160	4	25	C-5A
34316		230	4	18	C-7A

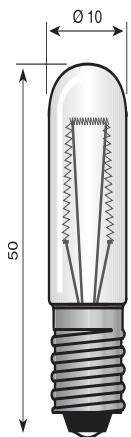

### Röhrenlampen 10x50 mm, Sockel E10

Bestell-Nr. Order-No.	Ausführung Type	Volt Volt	Watt Watt	mA mA	Wendel Filament
34320		24	3	125	C-2F
34321		30	3	100	C-2F
34322		60	3	50	C-2F
34323		130	4	30	C-5A
34324		160	4	25	C-5A
34325		230	4	18	C-7A

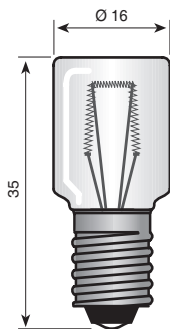

### Röhrenlampen 16x35 mm, Sockel E10

Bestell-Nr. Order-No.	Ausführung Type	Volt Volt	Watt Watt	mA mA	Wendel Filament
30340		220-260	5-7		C-7A

### Röhrenlampen 16x43 mm, Sockel E10

Bestell-Nr. Order-No.	Ausführung Type	Volt Volt	Watt Watt	mA mA	Wendel Filament
34317		24	5	210	C-2F

ohne Abbildung

# Kleinkugellampen

## Miniature lamps

### Kugellampen 11x24 mm, Sockel E10

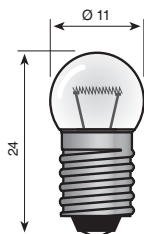

Bestell-Nr. Order-No.	Ausführung Type	Volt Volt	Watt Watt	mA mA	Wendel Filament
34100		1,25	0,3	250	C-2R
34101		1,3	0,19	150	C-2R
34103		1,5	0,13	90	C-2R
34105		1,5	0,3	200	C-2R
34107		1,5	0,45	300	C-2R
30822		2,2	0,44	200	C-2R
30820		2,5	0,15	60	C-2R
34124		2,5	0,25	100	C-2R
30025		2,5	0,5	200	C-2R
30026		2,5	0,75	300	C-2R
30039		2,5	1,25	500	C-2R
30823		3,5	0,52	150	C-2R
30027		3,5	0,7	200	C-2R
30824		3,5	1,15	300	C-2R
30028		3,8	0,27	70	C-2R
30825		3,8	1,14	300	C-2R
30829		4	0,16	40	C-2V
30830		4	1,2	300	C-2R
34108		4	2	500	C-2R
34156		4,8	1,44	300	C-2R
34106		6	0,3	50	C-2V
34109		6	0,35	60	C-2V
24080		6	0,6	100	C-2V
24083		6	1,1	180	C-2V
30601		6	2,1	350	C-2R
34102		6	3	500	C-2R
34122		6	3,6	600	C-2R
34123		6	5	830	C-2R
24060		6,2	1,86	300	C-2R
34126		6,2	3	484	C-2R
30657		6,5	1,95	300	C-2R
34128		7	0,7	100	C-2V
34129		7	2,1	300	C-2R
30650		12	0,6	50	C-2V
30658		12	1,2	100	C-2V
30600		12	1,1	185	C-2V
30602		12	3	250	C-2R
30605		12	4,8	400	C-2R
30610		18	1,8	100	C-2V
30611		19	0,76	40	C-2V
30612		24	1,2	50	C-2F
30603		24	2	80	C-2F
30607		24	2,4	100	C-2F
30613		24	2,8	120	C-2F
30604		24	3	125	C-2F
30609		24	5	210	C-2F

# Kleinkugellampen

## Miniature lamps

### Kugellampen 15x29 mm, Sockel E10

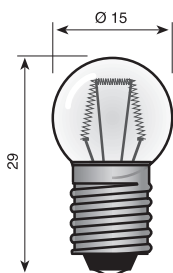

Bestell-Nr. Order-No.	Ausführung Type	Volt Volt	Watt Watt	mA mA	Wendel Filament
30700		2,4	1,5	625	C-2R
30894		2,4	2,4	1000	C-2R
30713		2,5	1,25	500	C-2R
30703		2,5	3	1250	C-2R
30707		3,5	0,7	200	C-2R
30764		4	2,8	700	C-2R
30734		6	0,3	50	C-2R
30701		6	2,1	350	C-2R
30712		6	2,7	450	C-2R
30714		6	3	500	C-2R
30735		6	5	830	C-2R
30797		6	6	1000	C-2R
30715		7	1,44	240	C-2R
30740		12	1,2	100	C-2V
34149		12	2	170	C-2V
30717		12	2,4	200	C-2V
30702		12	3	250	C-2V
30718		12	4	330	C-2R
30741		12	5	410	C-2R
30726		12	6	500	C-2R
30719		24	1,2	50	C-2F
30704		24	3	125	C-2F
30720		24	3,6	150	C-2F
30705		24	5	210	C-2F
30721		28	4,2	150	C-2F
30706		30	3	100	C-2F
30708		30	5	165	C-2F
30836		42	3	70	C-2F
30722		48	3	60	C-2F
30728		48	5	105	C-2F
30709		60	3	105	C-2F
30710		60	5	83	C-2F

# Kleintröhrenlampen

## Miniature lamps

### Kleintröhrenlampen 9x23 mm, Sockel BA9s

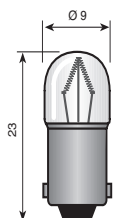

Bestell-Nr. Order-No.	Ausführung Type	Volt Volt	Watt Watt	mA mA	Wendel Filament
30133		2,5	1,25	500	C-2R
30128		4	1	250	C-2R
30135		6	0,24	40	C-2R
30137		6	0,3	50	C-2V
30151		6	0,6	100	C-2V
30134		6	1,1	180	C-2V
30152		6	1,2	200	C-2V
30153		6	2	333	C-2V
30138		6	2,1	350	C-2R
30136		6	3	500	C-2R
30140		6	4	666	C-2R
30142		6,3	1,6	250	C-2R
30143		12	0,24	20	C-2V
30154		12	0,6	50	C-2V
30155		12	1,2	100	C-2V
30139		12	1,44	120	C-2V
30156		12	2	165	C-2V
30147		12	2,2	180	C-2R
30157		12	3	250	C-2R
30144		18	1,8	100	C-2V
30145		24	0,6	25	C-2F
30159		24	1,2	50	C-2F
30160		24	2	80	C-2F
30161		24	3	125	C-2F
30148		24	4	165	C-2F
30149		26	1	38	C-2F
30162		26	3	115	C-2F
34222		28	1,1	40	C-2F
30177		28	2	70	C-2F
34260		30	1,2	40	C-2F
30163		30	1,5	50	C-2F
30164		30	2,1	70	C-2F
30165		30	3	100	C-2F
30166		36	1,8	50	C-2F
30179		36	2,8	80	C-2F
30168		42	2	45	C-2F
30283		42	3	70	C-2F
30290		48	1	20	C-2F
30182		48	1,2	25	C-2F
30169		48	2	40	C-2F
30170		48	3	60	C-2F
30172		60	1,2	20	C-2F
30173		60	2	33	C-2F
30174		60	2,4	40	C-2F
30183		60	3	50	C-2F
30294		70	2,8	40	C-2F
32007		80	1,6	20	C-3A
30337		80	2,4	30	C-3A
30341		130	2,6	20	C-5A
30344		220	3	14	C-7A
30185		240	3	13	CC-7A



# Kleinröhrenlampen

## Miniature lamps

### Röhrenlampen 10x28mm, Sockel BA9s

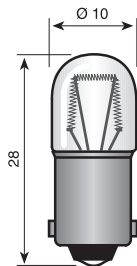

Bestell-Nr. Order-No.	Ausführung Type	Volt Volt	Watt Watt	mA mA	Wendel Filament
34302		2,5	0,75	300	C-2R
30329		2,5	1,25	500	C-2R
34303		3	2	650	C-2R
30288		3,5	0,7	200	C-2R
34304		3,6	0,54	150	C-2R
34305		4	1	250	C-2R
30291		4	1,2	300	C-2R
30292		4	2	500	C-2R
30300		5	0,25	50	C-2R
30325		5	0,45	90	C-2R
30327		6	0,3	50	C-2V
30328		6	0,45	75	C-2V
34306		6	0,6	100	C-2V
30336		6	1,1	180	C-2V
30251		6	1,2	200	C-2V
34307		6	1,8	300	C-2R
30252		6	2	350	C-2R
30253		6	3	500	C-2R
30338		6	4	700	C-2R
30326		6	5	830	C-2R
34308		6	6	1000	C-2R
30330		6,3	1	150	C-2V
30343		6,3	1,6	250	C-2R
34309	Blinklampe, Bimetal	6,3	300	320	C-2R
34326		6,3	2	320	C-2R
34327		6,5	1,95	300	C-2R
34214		7	0,7	100	C-2V
34328		7	2,1	300	C-2R
34329		7	4	570	C-2R
30375		10	0,5	50	C-2V
34213		10	2	200	C-2V
30254		12	0,6	50	C-2V
34330		12	1,2	100	C-2V
30255		12	1,5	120	C-2V
34331		12	1,8	150	C-2V
30256		12-15	2	165	C-2V
34332		12	2,2	183	C-2V
30257		12	3	250	C-2R
34333		12	4	330	C-2R
34211		12	5	417	C-2R
30388		14	1,1	80	C-2V
34335		14	1,4	100	C-2V
30389		14	2,8	200	C-2R
34336		14	3,35	240	C-2R

# Kleindröhrenlampen

## Miniature lamps

### Röhrenlampen 10x28mm, Sockel BA9s

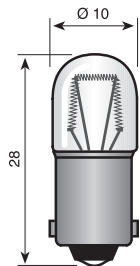

Bestell-Nr. Order-No.	Ausführung Type	Volt Volt	Watt Watt	mA mA	Wendel Filament
34337		15	0,75	50	C-2F
34338		18	1,8	100	C-2V
34339		18	3	170	C-2V
30258		24	0,6	25	C-2F
34340		24	1	40	C-2F
30259		24	1,2	50	C-2F
30260		24	2	80	C-2F
30261		24	3	125	C-2F
30396		24	4	165	C-2F
30262		24	5	208	C-2F
34341		27	2	75	C-2F
34342		28	0,7	25	C-2F
34146		28	1,1	40	C-2F
34343		28	1,4	50	C-2F
34344		28	2	70	C-2F
34345		28	2,2	80	C-2F
30399		28	2,8	100	C-2F
30422		28	5	170	C-2F
34346		28	5,6	200	C-2F
34245		30	1,2	40	C-2F
30263		30	1,5	50	C-2F
34347		30	1,8	60	C-2F
30264		30	2,1	70	C-2F
30244		30	2,4	80	C-2F
30265		30	3	100	C-2F
30266		30	5	167	C-2F
34348		32	5,4	170	C-2F
30428		36	0,72	20	C-2F
30267		36	1,8	50	C-2F
34349		36	2	55	C-2F
30269		36	3	85	C-2F
34350		36	3,6	100	C-2F
34351		42	1	25	C-2F
30270		42	2	50	C-2F
30432		42	3	70	C-2F
30434		48	1	20	C-2F
34352		48	1,2	25	C-2F
30271		48	2	40	C-2F
30272		48	2,5	50	C-2F
30273		48	3	60	C-2F
34272		48	4	80	C-2F
34267		48	5	105	C-2F
30436		50	2,5	50	C-2F

# Kleinröhrenlampen

## Miniature lamps

### Röhrenlampen 10x28mm, Sockel BA9s

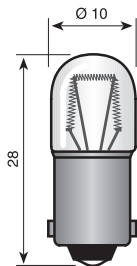

Bestell-Nr. Order-No.	Ausführung Type	Volt Volt	Watt Watt	mA mA	Wendel Filament
34353		52	3	60	C-2F
34354		55	2,75	50	C-2F
30274		60	1,2	20	C-2F
34355		60	1,8	30	C-2F
30275		60	2	33	C-2F
30276		60	2,4	40	C-2F
30277		60	3	50	C-2F
32018		60	5	85	C-2F
30278		70	1,4	20	C-2F
30279		70	2,8	40	C-2F
32024		80	2	25	C-3A
32025		80	3,2	40	C-3A
34356		85	2	24	C-3A
30286		85	3	35	C-3A
34357		110	2,5	22	CC-6A
24020		130	2	15	C-5A
34358		130	2,4	18	C-5A
30280		130	2,6	20	C-5A
34254		160	3,2	20	C-5A
30282		220-240	2	9	C-7A
30281		220-240	3-4	14	C-7A
34227		240	2,4	10	CC-7A
34360		240	3	13	CC-7A

# Kleinhöhrenlampen

## Miniature lamps

### Röhrenlampen 10x38mm, Sockel BA9s

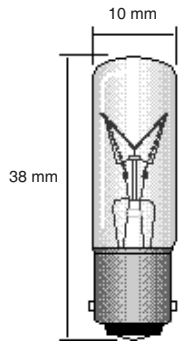

Ba9s  
Abb. ähnlich

Bestell-Nr. Order-No.	Ausführung Type	Volt Volt	Watt Watt	mA mA	Wendel Filament
34361		30	3	100	C-2F
34362		48	3	63	C-2F
34363		60	3	50	C-2F
34364		130	2,6	20	C-5A
34365		160	4	22	C-5A
34366		230	4	17	C-6A

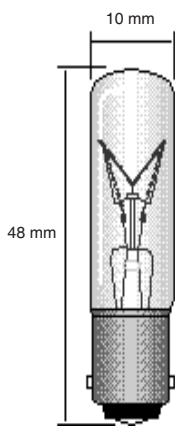

Ba9s  
Abb. ähnlich

### Röhrenlampen 10x48mm, Sockel BA9s

Bestell-Nr. Order-No.	Ausführung Type	Volt Volt	Watt Watt	mA mA	Wendel Filament
34367		30	3	100	C-2F
34368		85	4	47	C-2F
34369		130	4	30	C-5A



C-2F  
CC-2F



C-5A



C-6A  
CC-6A

# Kugellampen

## Miniature lamps

### Kugellampen 11x24mm, Sockel BA9s

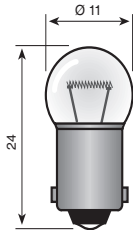

Bestell-Nr. Order-No.	Ausführung Type	Volt Volt	Watt Watt	mA mA	Wendel Filament
34150		2,5	0,5	200	C-2R
34151		2,5	0,75	300	C-2R
30659		3,5	0,7	200	C-2R
30984		4,8	1,45	300	C-2R
34152		6	0,3	50	C-2V
30821		6	0,6	100	C-2V
34153		6	1,1	180	C-2V
34154		6	1,8	300	C-2R
30651		6	2	333	C-2R
34155		6	3	500	C-2R
34158		7	0,7	100	C-2V
34159		7	2,1	300	C-2R
34162		12	0,6	50	C-2V
34163		12	1,2	100	C-2V
34164		12	2	165	C-2V
34165		12	2,2	185	C-2R
30652		12	3	250	C-2R
34166		18	1,8	100	C-2V
34167		24	1,2	50	C-2F
30653		24	2	80	C-2F
34168		24	2,4	100	C-2F
30654		24	3	125	C-2F
34169		30	1,2	40	C-2F
34140		30	3	100	C-2F

### Kugellampen 15x29mm, Sockel BA9s

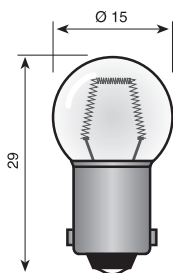

30780		2,4	1,2	500	C-2R
30784		2,4	3	1250	C-2R
30771		6	1,2	200	C-2V
30751		6	2	333	C-2R
30748		6	3	500	C-2R
30796		6	5	830	C-2R
30776		6	6	1000	C-2R
30752		12	3	250	C-2R
30749		12	5	417	C-2R
30792		12	6	500	C-2R
30794		14	1,7	120	C-2V
30798		14	3,4	240	C-2V
30753		24	2	80	C-2F
30754		24	3	125	C-2F
30799		24	4	165	C-2F
30755		24	5	208	C-2F
30773		28	5	170	C-2F
30756		30	3	165	C-2F
30782		48	5	105	C-2F
30760		60	5	85	C-2F

### Röhrenlampen 10x28mm, Sockel BA10s

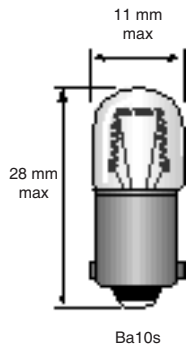

Bestell-Nr. Order-No.	Ausführung Type	Volt Volt	Watt Watt	mA mA	Wendel Filament
34170		4	2,4	600	C-2F
34171		6	1,8	300	C-2R
34172		6	3	500	C-2R
30245		12	3	250	C-2V
30246		24	3	125	C-2F
34173		24	5	208	C-2F
34174		30	2	67	C-2F
34175		30	3	100	C-2F
34176		48	3	62	CC-2F
30248		65	3	46	CC-2F
30249		65	5,5	85	CC-2F
34143		130	2,6	20	CC-2F

**Wir führen ab Lager:** Anzeigelampen, Signallampen, Spezial-Kleinlampen, Subminiaturlampen, Fernmelde-lampen, Telefonlampen, Glassockellampen, Spezial-Lichtwurf lampen, Kleinst-Piccolo-Glimmlampen, Groß-Glimm-lampen, Autolampen, Fotolampen, optische Lampen, Projektionslampen, Allgebrauchslampen, Leuchtstofflampen, Sonder-Leuchtstofflampen, Entladungslampen, Deko-Lampen, Halogenlampen, Kohlefadenlampen, Pflanzlicht-lampen, Schwarzlichtlampen, Deko-Kerzenlampen, Flacker-Windstosskerzen, Effekt-Lampen, Reflektorlampen, Pressglasreflektorlampen, Cool-Beam Lampen, Dichro-Color Farbfilterlampen, Speziallicht für Frischprodukte, Kaltlichtspiegellampen, Entkeimungslampen, Lampen für medizinische Geräte, OP-Beleuchtungslampen uvm.

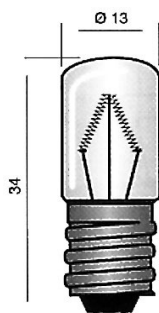

### Röhrenlampen 13x34mm, Sockel E12

Bestell-Nr. Order-No.	Ausführung Type	Volt Volt	Watt Watt	mA mA	Wendel Filament
30347		18	2	110	C-2V
32121		24	3	110	C-2V
30346		28	2	70	C-2V
30349		30	2	65	C-2F
30626		110	3	27	C-5A
30361		110	5	45	C-5A
30627		130	6	46	C-5A
30628		220	5	23	C-7A

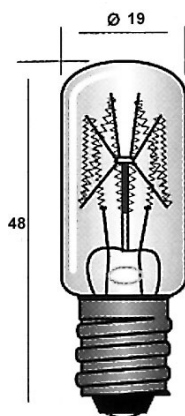

### Röhrenlampen 19x48mm, Sockel E12

Bestell-Nr. Order-No.	Ausführung Type	Volt Volt	Watt Watt	mA mA	Wendel Filament
30378		6	6		C-2R
32119		12	6		C-2V
34147		24	5		C-2V
30392		30	6		C-2V
30397		32	6		C-2V
32103		48	6		C-5A
32105		60	6		C-5A
32106		75	6		C-5A
32107		120	6		C-5A
32109		130	4		C-5A
32111		250	7		C-5A
34144		250	10		C-5A

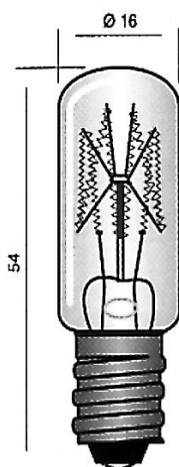

### Röhrenlampen 16x54mm, Sockel E12

Bestell-Nr. Order-No.	Ausführung Type	Volt Volt	Watt Watt	mA mA	Wendel Filament
34269		24-30	6-10		C-2V
34226		65-95	6-10		C-3A
34265		110-140	6-10		C-5A
30391		220-260	5-7		C-7A
34224		220-260	6-10		C-7A

# Röhrenlampen

## Miniature lamps

### Röhrenlampen 14x30mm, Sockel E14

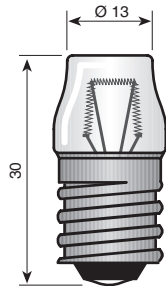

Bestell-Nr. Order-No.	Ausführung Type	Volt Volt	Watt Watt	mA mA	Wendel Filament
30301		6	1,1	180	C-2V
30302		6	3	500	C-2R
30550		6	5	850	C-2R
30303		12	1,5	120	C-2V
30304		12	2	165	C-2V
30305		12	3	250	C-2V
30554		12	5	410	C-2R
30307		24	1,2	50	C-2F
30308		24	2	80	C-2F
30309		24	3	125	C-2F
30310		24	5	210	C-2F
30560		30	1,5	50	C-2F
30312		30	2	70	C-2F
30313		30	3	100	C-2F
30314		30	5	166	C-2F
30518		36	2	55	C-2F
30562		36	3	80	C-2F
30563		36	5	140	C-2F
30315		42	2	50	C-2F
30539		42	3	70	C-2F
30559		42	5	120	C-2F
30316		48	2	40	C-2F
30317		48	3	60	C-2F
30318		48	5	105	C-2F
30566		60	1,2	20	C-2F
30320		60	2,4	40	C-2F
30321		60	3	50	C-2F
30322		60	5	85	C-2F
30323		70	2,8	40	C-2F
32021		80	3	35	C-3A
32029		110	5	45	C-5A
32034		130	2,6	20	C-5A
32020		130	5	40	C-5A
32036		220	3	14	C-7A
30324		220-260	5-7	23	C-7A



# Röhrenlampen

## Miniature lamps

### Röhrenlampen 16x35mm, Sockel E14

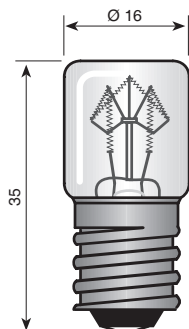

Bestell-Nr. Order-No.	Ausführung Type	Volt Volt	Watt Watt	mA mA	Wendel Filament
34282		6	1		C-2R
34287		6	2		C-2R
34288		6	5		C-2R
34289		8	3		C-2R
34300		12	2		C-2R
34301		12	3		C-2R
34334		12	5		C-2R
30614		24	2		C-2V
30592		24	3		C-2V
30615		24	4		C-2V
30331		24	5		C-2V
30608		30	3		C-2V
30332		30	5		C-2V
30616		36	3		C-2F
30617		36	5		C-2F
30618		42	5		C-2F
30619		48	3		C-3A
30596		48	5		C-3A
30620		60	2		C-3A
30621		60	3		C-3A
30333		60	5		C-3A
30334		110	5		C-5A
30622		130	2,6		C-5A
30623		130	5		C-5A
32046		140	7		C-5A
30624		150	5		C-5A
30625		160	5		C-5A
30339		220-260	3-5		C-7A
30335		220-260	5-7		C-7A
32049		220-260	6-10		C-7A

### Röhrenlampen 16x45mm, Sockel E14

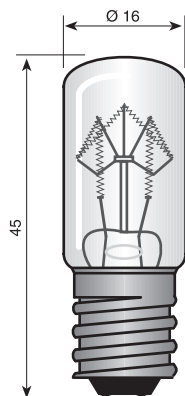

Bestell-Nr. Order-No.	Ausführung Type	Volt Volt	Watt Watt	mA mA	Wendel Filament
34232		6	5		C-2R
34236		12	5		C-2R
34279		24	3		C-2V
34239		24	5		C-2V
34243		24	10		C-2V
34275		24	15		C-2V
34177		24-30	6-10		C-2V
34178		30	5		C-2V
34179		30	5-7		C-2V
34180		36	5		C-2F
34181		42	5		C-2F
34182		48	5		C-3A
34183		60	5		C-3A
34184		60	10		C-3A
34185		110	5		C-5A
34186		110-140	6-10		C-5A
34187		130	5		C-5A
34228		140	7		C-5A
34223		160	5		C-5A
34220		220	10		C-7A
34212		220-260	5-7		C-7A
34216		220-260	6-10		C-7A
34210		380	10		C-7A

# Röhrenlampen

## Miniature lamps

### Röhrenlampen 16x54mm, Sockel E14

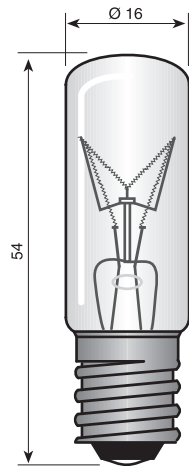

Bestell-Nr. Order-No.	Ausführung Type	Volt Volt	Watt Watt	Wendel Filament
31901		4	5	C-2R
31904		6	3	C-2R
30401		6	5	C-2R
32139		12	3	C-2R
31911		12	4	C-2R
30402		12	5	C-2R
30403		12	10	C-2R
30404		12	15	C-2R
30405		24	2	C-2V
30406		24	4	C-2V
30407		24	5	C-2V
30408		24	10	C-2V
30409		24	15	C-2V
31906		24-30	3-5	C-2V
30410		24-30	6-10	C-2V
31916		30	3	C-2V
30411		30	5	C-2V
31919		30	15	C-2V
30413		36	5	C-2F
30414		36-45	6-10	C-2F
31922		42	3	C-2F
30415		42	5	C-2F
31923		42	7	C-2V
31976		42	10	C-2F
31907		42	15	C-2F
31926		48	3	C-3A
30416		48	5	C-3A
31910		48	10	C-3A
31928		48	15	C-3A
30417		48-60	6-10	C-3A
34231		60	4	C-3A
30418		60	5	C-3A
32050		60	7	C-3A
31912		60	10	C-3A
34219		65	15	C-3A
32052		65-95	6-10	C-3A

### Röhrenlampen 16x54mm, Sockel E14

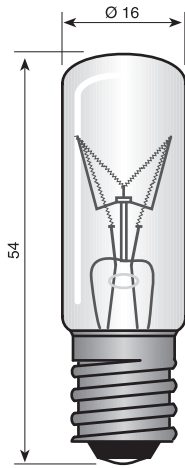

Bestell-Nr. Order-No.	Ausführung Type	Volt Volt	Watt Watt	Wendel Filament
32055		80	5	C-3A
32023		80	7	C-3A
32026		80	15	C-3A
32009		110	10	C-5A
34278		110	15	C-5A
30424		110-140	5-7	C-5A
30419		110-140	6-10	C-5A
32079		130	5	C-5A
32064		130	15	C-5A
32067		150	5	C-5A
32000		220	5	C-7A
32001		220	10	C-7A
32003		220	15	C-7A
32070		220-260	3-5	C-7A
30420		220-260	5-7	C-7A
30421		220-260	6-10	C-7A
32071		220-260	10-15	C-7A
32075		380	10	CC-7A

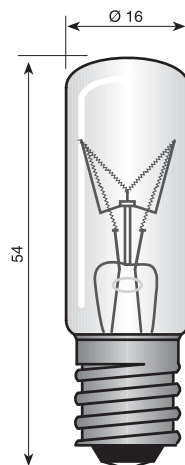

### OSRAM-Type Röhrenlampen 16x54mm, Sockel E14

Bestell-Nr. Order-No.	Ausführung Type	Volt Volt	Watt Watt
304101	6814	30/24	10/6

### Röhrenlampen 14x30mm, Sockel Ba15d

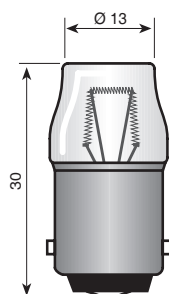

Ba15d



Bestell-Nr. Order-No.	Ausführung Type	Volt Volt	Watt Watt	mA mA	Wendel Filament
30567		6	1,1	180	C-2V
30352		6	3	500	C-2R
30568		6	5	850	C-2R
30353		12	1,5	120	C-2V
30354		12	2	166	C-2V
30355		12	3	250	C-2V
35005		12	5	410	C-2R
30357		24	1,2	50	C-2V
30358		24	2	80	C-2F
30359		24	3	125	C-2V
30360		24	5	200	C-2V
30362		30	2	70	C-2V
30363		30	3	100	C-2V
30364		30	5	166	C-2V
30365		42	2	50	C-2F
30366		48	2	40	C-2F
30367		48	3	62	C-2F
30368		48	5	100	C-3A
30577		60	1,2	20	C-2F
30370		60	2,4	40	C-2F
30371		60	3	50	C-2F
30372		60	5	83	C-3A
30373		70	2,8	40	C-3A
39999		220	3	14	C-7A
30374		220	5	19	C-7A

### Röhrenlampen 16x35mm, Sockel Ba15d

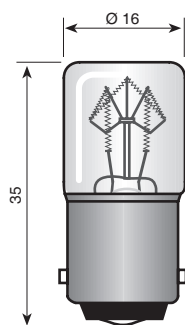

Ba15d



Bestell-Nr. Order-No.	Ausführung Type	Volt Volt	Watt Watt	mA mA	Wendel Filament
32031		6	1,2		C-2R
32039		6	2		C-2R
30584		6	5		C-2R
32041		12	1,5		C-2V
32047		12	2		C-2R
30586		12	5		C-2R
32048		24	2		C-2F
30587		24	3		C-2F
30380		24	5		C-2F
30599		30	3		C-2F
30381		30	5		C-2F
32057		36	3		C-2F
32058		36	5		C-2F
32059		48	3		C-3A
30589		48	5		C-3A
32060		60	2		C-3A
32061		60	3		C-3A
30382		60	5		C-3A
32063		85	4		C-3A
32066		110	3		C-5A
30383		110	5		C-5A
32042		130	5		C-5A
32069		140	7		C-5A
32043		150	5		C-5A
32044		160	5		C-5A
32072		220	3		C-7A
32073		220	5		C-7A
32078		220-260	3-5		C-7A
30384		220-260	5-7		C-7A
32082		220-260	6-10		C-7A

# Röhrenlampen

## Miniature lamps

### Röhrenlampen 16x45mm, Sockel Ba15d

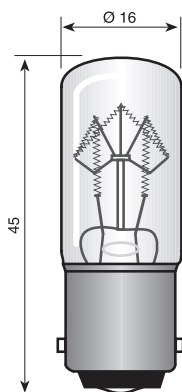

Bestell-Nr. Order-No.	Ausführung Type	Volt Volt	mA mA	Watt Watt	Wendel Filament
35001		6		3	C-2R
35002		6		4	C-2R
35004		6		5	C-2R
35006		12		4	C-2R
35007		12		5	C-2R
35008		12		10	C-2R
35009		12		15	C-2R
35010		24		3	C-2V
35011		24		4	C-2V
35012		24		5	C-2V
31945		24		10	C-2V
35013		24		15	C-2V
31947		24-30		6-10	C-2V
35014		30		5	C-2V
35015		30		12	C-2F
30412		36		5	C-2F
35016		42		5	C-2F
35017		48		5	C-3A
35018		48		10	C-3A
35019		60		4	C-3A
35020		60		5	C-3A
35021		80		6	C-3A
35022		110		10	C-5A
35023		110-140		5-7	C-5A
35024		110-140		6-10	C-5A
35025		130		5	C-5A
35026		220-260		5-7	C-7A
35027		220-260		6-10	C-7A
35028		240		15	C-7A
35029		250		15	C-7A
35030		380		10	C-7A

### Röhrenlampen 16x54mm, Sockel Ba15d

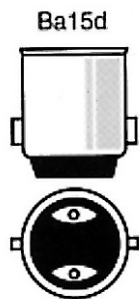
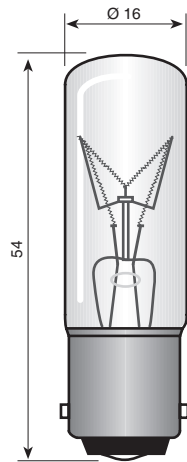

Bestell-Nr. Order-No.	Ausführung Type	Volt Volt	Watt Watt	mA mA	Wendel Filament
31934		6	3		C-2R
30451		6	5		C-2R
31939		6	15		C-2R
31941		12	3		C-2R
30452		12	5		C-2R
30453		12	10		C-2R
30454		12	15		C-2R
30455		24	2		C-2V
31943		24	3		C-2V
30456		24	4		C-2V
30457		24	5		C-2V
30458		24	10		C-2V
30459		24	15		C-2V
30462		24-30	3-5		C-2V
30460		24-30	6-10		C-2V
31949		30	3		C-2V
30461		30	5		C-2V
31946		30	5-7		C-2V
30463		36	5		C-2F
30464		36-45	6-10		C-2F
31956		42	3		C-2V
30465		42	5		C-2F
31958		42	10		C-2V
31954		42	15		C-2F
31961		48	3		C-3A
30466		48	5		C-3A
31964		48	10		C-3A
31965		48	15		C-3A
30467		48-60	7-10		C-3A
32076		60	4		C-3A
32094		60	5		C-3A
32077		60	7		C-3A
32118		60	10		C-3A
32056		65-95	6-10		C-3A
30472		110	5		C-5A
30469		110-140	6-10		C-5A
32089		130	5		C-5A
32128		130	10		C-5A



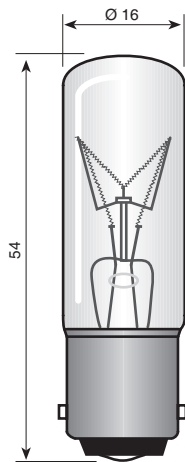

Ba15d



### Röhrenlampen 16x54mm, Sockel Ba15d

Bestell-Nr. Order-No.	Ausführung Type	Volt Volt	Watt Watt	mA mA	Wendel Filament
32130		160	10		C-5A
32133		220	5		C-7A
32134		220	15		C-7A
32097		220-260	3-5		C-7A
30470		220-260	5-7		C-7A
30471		220-260	6-10		C-7A
32099		220-260	10-15		C-7A
32141		240	15		C-7A
32100		380	10		C-7A

### OSRAM-Type Röhrenlampen 16x54mm, Sockel Ba15d

Bestell-Nr. Order-No.	Ausführung Type	Volt Volt	Watt Watt
304601	6815	30/24	10/6
304671	6819	60/48	10/6
304691	6823	140/110	10/6
304711	6825	260/220	10/6

# Birnformlampen

## Miniature lamps

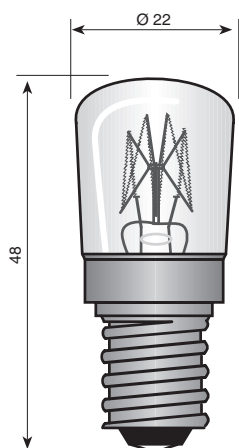

### Birnformlampen 22x48mm, Sockel E14

Bestell-Nr. Order-No.	Ausführung Type	Volt Volt	Watt Watt
33506	klar	12	15
33512	klar	24	5
33511	klar	24	10
33517	klar	24	15
33525	klar	60	15
33527	klar	130	5
33535	klar	130	10
33537	klar	130	15
33538	klar	220-260	5-7
33589	klar	220-260	6-10
33540	klar	220-260	10-15

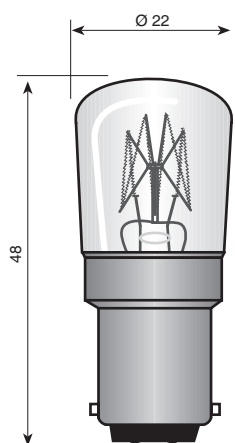

### Birnformlampen 22x48mm, Sockel Ba15d

Bestell-Nr. Order-No.	Ausführung Type	Volt Volt	Watt Watt
33560	klar	12	15
33564	klar	24	5
33565	klar	24	10
33567	klar	24	15
33582	klar	130	15
33577	klar	220-260	5-7
33578	klar	220-260	6-10
33575	klar	220-260	10-15

Ba15d



# Birnformlampen

## Miniature lamps

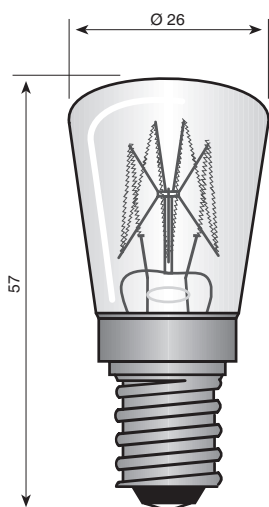

### Birnformlampen 26x57mm, Sockel E14

Bestell-Nr. Order-No.	Ausführung Type	Volt Volt	Watt Watt
30805	OSRAM 6514	24	10
30806	klar	24	15
30808	klar	42	15
30809	klar	42	25
30810	klar	65	10
30811	klar	65	15
30812	klar	65	25
30813	klar	110	15
30814	klar	110	25

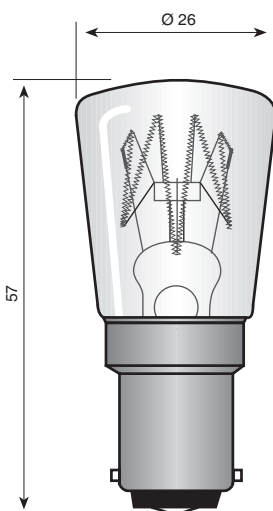

### Birnformlampen 26x57mm, Sockel Ba15d

Bestell-Nr. Order-No.	Ausführung Type	Volt Volt	Watt Watt
30853	klar	24	15
30854	klar	24	25
30859	klar	220-235	15
30860	klar	220-235	25

Ba15d



# Tropfenlampen

## Niedervolt-Tropfenlampen 45x70mm, matt, Sockel E14

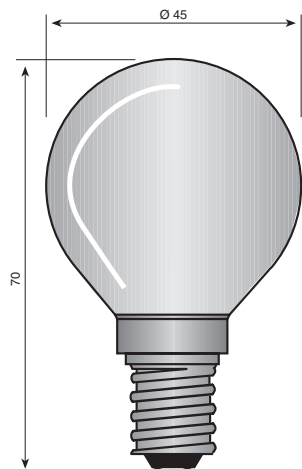

Bestell-Nr. Order-No.	Volt Volt	Watt Watt
45510	12	25
30903	24	15
30904	24	25
45415	24	40
45425	42	15
45427	42	25
45429	42	40
45436	65	15
45438	65	25
45440	65	40
45460	125-130	15
45462	125-130	25
45463	125-130	40

# Standardlampen

## Niedervolt-Standardlampen 60x105mm, matt, Sockel E27

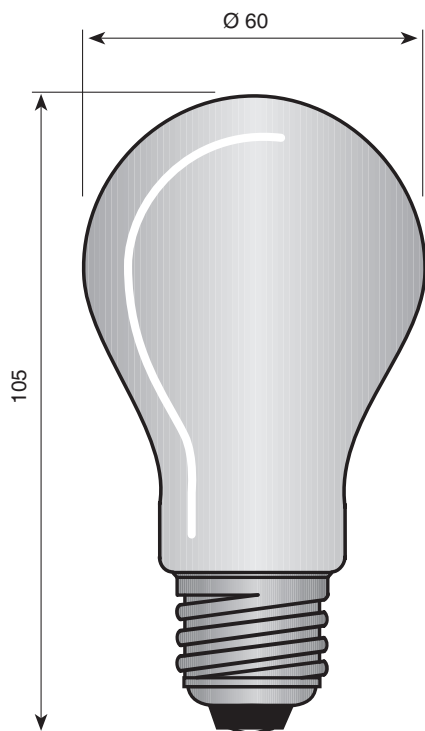

Bestell-Nr. Order-No.	Volt Volt	Watt Watt
40100	12	15
40101	12	25
40102	12	40
40103	12	60
40109	24	15
40110	24	25
40112	24	40
40114	24	60
40116	24	100
40129	42	15
40130	42	25
40132	42	40
40134	42	60
40136	42	100
40149	65	15
40150	65	25
40152	65	40
40154	65	60
40158	65	100
40170	125-130	15
40160	125-130	25
40162	125-130	40
40173	125-130	60

# Telefonstecklampen

## Telephone lamps

### Telefonlampen T4,5 4x16mm

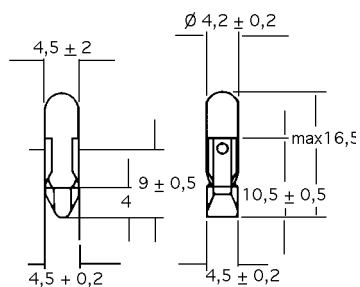

Bestell-Nr. Order-No.	Volt Volt	mA mA	Lebensdauer Life / h	Wendel Filament
32701	5	80	5.000	C-2V
32702	5	120	5.000	C-2V
32706	6	20	10.000	C-2V
31001	6	50	5.000	C-2R
32708	6	100	5.000	C-2V
32709	6	200	5.000	C-2R
31002	12	20	10.000	C-2V
31003	12	40	10.000	C-2V
31000	12	50	10.000	C-2V
25010	12	100	5.000	C-2V
31004	24	20	10.000	C-2F
31012	24	30	10.000	C-2F
31013	24	40	10.000	C-2F
31005	24	50	10.000	C-2F
31006	30	20	10.000	C-2F
32704	30	40	10.000	C-2F
32705	36	20	10.000	C-2F
32700	36	35	5.000	C-2F
31007	48	20	5.000	CC-2F
31014	48	30	5.000	CC-2F
31008	60	20	5.000	CC-2F

# Telefonstecklampen

## Telephone lamps

### Telefonlampe T4,6 4x22mm

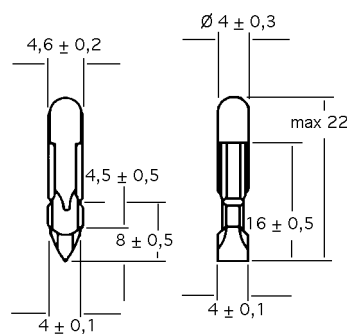

Bestell-Nr. Order-No.	Volt Volt	mA mA	Lebensdauer Life / h	Wendel Filament
32606	5	80	5.000	C-2V
31051	6	20	10.000	C-2V
31052	6	40	10.000	C-2V
32601	6	50	5.000	C-2V
31050	6	100	5.000	C-2V
31064	6	200	5.000	C-2R
31053	12	20	10.000	C-2V
31054	12	40	10.000	C-2V
31055	12	50	10.000	C-2V
31065	12	100	5.000	C-2V
32609	16	60	5.000	C-2F
32603	18	25	5.000	C-2F
31056	24	20	10.000	C-2F
31066	24	30	10.000	C-2F
31063	24	40	10.000	C-2F
31057	24	50	10.000	C-2F
31067	28	40	5.000	C-2F
31058	30	20	10.000	C-2F
31069	30	30	5.000	C-2F
31059	30	40	10.000	C-2F
31070	32	33	20.000	C-2F
31060	36	20	5.000	C-2F
31071	36	35	5.000	CC-2F
31061	48	20	5.000	CC-2F
31072	48	30	5.000	CC-2F
31073	60	15	5.000	CC-2F
31062	60	20	5.000	CC-2F

# Telefonstecklampen

## Telephone lamps

### Telefonlampe T5,5K 5x22mm

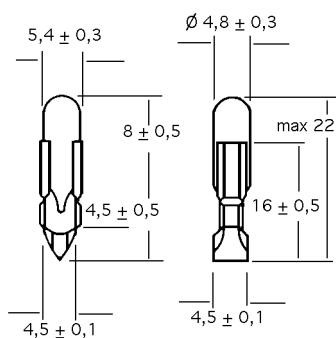

Bestell-Nr. Order-No.	Volt Volt	mA mA	Lebensdauer Life / h	Wendel Filament
31101	6	20	10.000	C-2V
31102	6	40	10.000	C-2V
31100	6	50	5.000	C-2V
32800	6	100	5.000	CC-6
32806	6	160	5.000	C-2R
32809	6	200	5.000	C-2R
31103	12	20	10.000	C-2V
31104	12	40	10.000	C-2V
31105	12	50	10.000	C-2V
32801	12	100	10.000	C-2V
25023	16	60	5.000	C-2F
25024	18	25	5.000	C-2F
31106	24	20	10.000	C-2F
32810	24	30	10.000	C-2F
32802	24	40	10.000	C-2F
31107	24	50	10.000	C-2F
32811	26	40	10.000	C-2F
32803	28	50	10.000	C-2F
31108	30	20	10.000	C-2F
31109	30	40	10.000	C-2F
32685	30	50	10.000	C-2F
32812	32	33	10.000	C-2F
31110	36	20	10.000	C-2F
31113	36	40	10.000	C-2F
31116	36	50	5.000	CC-2F
31111	48	20	5.000	CC-2F
32804	48	25	5.000	CC-2F
32813	48	30	5.000	CC-2F
32814	52	20	5.000	CC-2F
31112	60	20	5.000	CC-2F
32807	70	20	5.000	CC-2F

# Telefonstecklampen

## Telephone lamps

### Telefonlampe T5,5 5x30mm

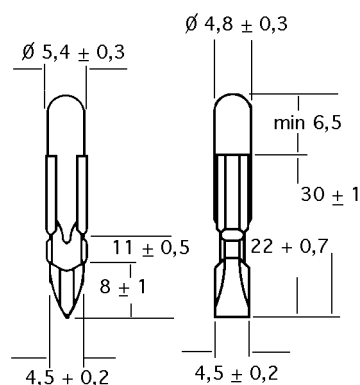

Bestell-Nr. Order-No.	Volt Volt	mA mA	Lebensdauer Life / h	Wendel Filament
31151	6	20	10.000	C-2V
31152	6	40	10.000	C-2V
32850	6	50	5.000	C-2V
32815	6	80	5.000	C-2R
32851	6	100	5.000	C-2R
31153	6	200	5.000	C-2R
31154	12	20	10.000	C-2V
31168	12	40	10.000	C-2V
31155	12	50	10.000	C-2V
32816	12	80	5.000	C-2V
31156	12	100	10.000	C-2V
32817	14	20	5.000	C-2F
32852	16	50	5.000	C-2F
25029	18	25	10.000	C-2F
25028	18	66	5.000	C-2F
31157	24	20	10.000	C-2F
32853	24	25	5.000	C-2F
32854	24	30	10.000	C-2F
32855	24	40	10.000	C-2F
31158	24	50	10.000	C-2F
32818	24	60	5.000	C-2F
31159	24	80	5.000	C-2F
32819	26	40	5.000	C-2F
32856	28	20	5.000	C-2F
32857	28	40	10.000	C-2F
32858	28	50	10.000	C-2F
32859	30	20	10.000	C-2F
25021	30	30	5.000	C-2F
31160	30	40	10.000	C-2F
32861	30	50	5.000	C-2F
32862	30	80	5.000	C-2F
32820	32	33	10.000	C-2F
31161	36	20	10.000	C-2F
32821	36	30	5.000	C-2F
32864	36	33	5.000	C-2F
32865	36	40	5.000	C-2F
32866	36	50	5.000	C-2F
32822	40	50	5.000	C-2F
31162	48	20	5.000	CC-2F
31163	48	25	5.000	CC-2F
32867	48	30	5.000	CC-2F
32868	48	40	5.000	CC-2F
31164	48	50	5.000	CC-2F
32823	52	20	5.000	CC-2F
31165	60	20	5.000	CC-2F
32869	60	30	5.000	CC-2F
32870	60	40	5.000	CC-2F
31167	70	20	5.000	CC-2F
32824	70	40	5.000	CC-2F
31169	80	20	5.000	CC-2F



# Telefonstecklampen

## Telephone lamps

### Telefonlampe T6,5 6x44mm

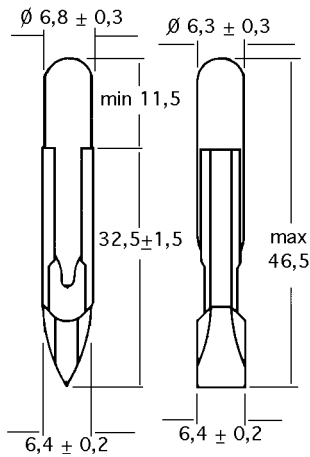

Bestell-Nr. Order-No.	Volt Volt	mA mA	Lebensdauer Life / h	Wendel Filament
35031	6	20	5.000	C-2V
35032	6	40	5.000	C-2V
35033	6	80	5.000	C-2R
35034	6	100	5.000	C-2R
35035	6	200	5.000	C-2R
35036	12	20	5.000	C-2V
35037	12	40	5.000	C-2V
35038	12	50	5.000	C-2V
35039	12	80	5.000	C-2V
35040	12	100	5.000	C-2V
35041	12	120	5.000	C-2V
35042	15	25	5.000	C-2V
35043	18	25	5.000	C-2F
35044	18	55	5.000	C-2F
35045	24	20	5.000	C-2F
35046	24	25	5.000	C-2F
35047	24	40	5.000	C-2F
35048	24	50	5.000	C-2F
35049	24	80	5.000	C-2F
35050	24	100	5.000	C-2F
35051	26	40	5.000	C-2F
35052	30	20	5.000	C-2F
35053	30	40	5.000	C-2F
35054	30	100	5.000	C-2F
35055	36	20	5.000	C-2F
35056	36	40	5.000	C-2F
35057	36	50	5.000	C-2F
35058	36	60	5.000	C-2F
35059	48	20	5.000	CC-2F
35060	48	25	5.000	CC-2F
35061	48	40	5.000	CC-2F
35062	48	50	5.000	CC-2F
35063	48	60	5.000	CC-2F
35064	52	20	5.000	CC-2F
35065	60	20	5.000	CC-2F
35066	60	40	5.000	CC-2F
35067	60	50	5.000	CC-2F
35068	60	60	5.000	CC-2F
35069	70	20	5.000	CC-2F
35070	85	24	5.000	CC-2F

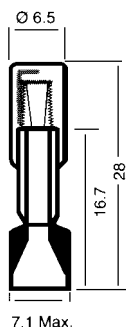

### Telefonlampe T6,8k 6x28mm (PSB)

32677	6	140	20.000	C-2F
32678	12	170	12.000	C-2F
32640	24	73	10.000	C-2F
32661	28	40	5.000	C-2F
32681	48	53	7.500	CC-2F
32684	60	50	7.500	CC-2F
32682	120	25	10.000	CC-7A
32687	155	25	10.000	CC-7A

# Telefonstecklampen

## Telephone lamps

### Telefonlampe T6,8 6x44mm

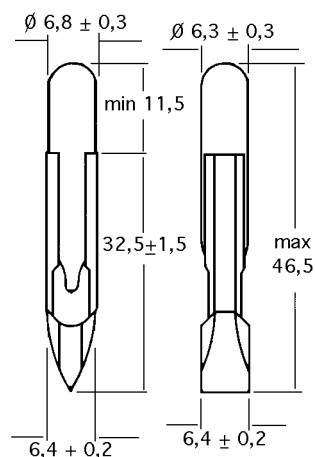

Bestell-Nr. Order-No.	Volt Volt	mA mA	Lebensdauer Life / h	Wendel Filament
31230	4	40	5.000	C-2V
31231	4	200	5.000	C-2R
31201	6	20	10.000	C-2V
31227	6	40	5.000	C-2V
31220	6	50	10.000	C-2V
31232	6	80	5.000	C-2V
31233	6	100	10.000	C-2V
32651	6	200	10.000	C-2V
31235	7	40	5.000	C-2V
31236	8	150	5.000	C-2V
31202	12	20	10.000	C-2V
31237	12	30	5.000	C-2V
32652	12	40	5.000	C-2V
31203	12	50	10.000	C-2V
31238	12	80	5.000	C-2V
31204	12	100	10.000	C-2V
31239	12	120	5.000	C-2V
31240	18	25	5.000	C-2F
31241	18	40	5.000	C-2F
31242	18	100	5.000	C-2F
32654	24	20	10.000	C-2F
31205	24	25	5.000	C-2F
31243	24	35	5.000	C-2F
31206	24	40	10.000	C-2F
31207	24	50	10.000	C-2F
31244	24	60	5.000	C-2F
32659	24	80	5.000	C-2F
31245	24	100	5.000	C-2F
31246	28	40	5.000	C-2F
32662	28	45	5.000	C-2F
31247	28	50	5.000	C-2F
31248	28	80	5.000	C-2F
25019	30	20	5.000	C-2F
25011	30	25	5.000	C-2F
31208	30	40	10.000	C-2F
32665	30	50	5.000	C-2F
31249	30	80	5.000	C-2F
31250	30	100	5.000	C-2F
31209	36	20	10.000	C-2F
31251	36	33	5.000	C-2F
32688	36	40	10.000	C-2F
31210	36	50	5.000	C-2F
31252	36	100	5.000	C-2F
31253	48	20	10.000	CC-2F
32668	48	25	5.000	CC-2F
31211	48	40	5.000	CC-2F
32669	48	50	5.000	CC-2F

# Telefonstecklampen

## Telephone lamps

### Telefonlampe T6,8 7x44mm

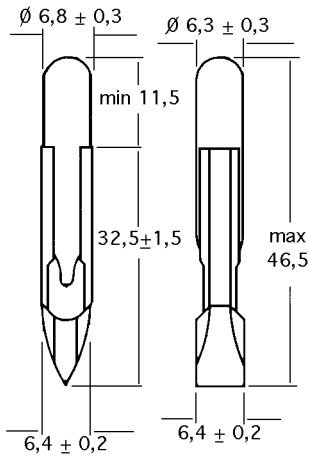

Bestell-Nr. Order-No.	Volt Volt	mA mA	Lebensdauer Life / h	Wendel Filament
32674	50	20	5.000	CC-2F
32670	50	50	5.000	CC-2F
31212	60	20	5.000	CC-2F
31213	60	40	5.000	CC-2F
32672	60	50	5.000	CC-2F
31223	60	60	5.000	CC-2F
31214	70	20	5.000	CC-2F
32675	70	25	5.000	CC-2F
32673	70	30	5.000	CC-2F
31215	70	40	5.000	CC-2F
31229	80	20	5.000	CC-2F
32679	80	40	5.000	CC-2F

### Telefonlampe ESB 6x23mm

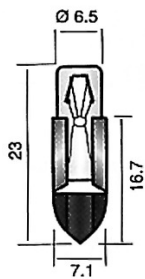

Bestell-Nr. Order-No.	Volt Volt	mA mA	Lebensdauer Life / h	Wendel Filament
32690	4	40	10.000	C-6
32691	5	40	8.000	C-6
32692	6	40	10.000	C-2F
32693	10	40	10.000	C-2V
32694	12	40	10.000	C-2V
32695	16	40	7.500	C-2F
32696	18	40	5.000	C-2V
32697	24	40	8.000	C-2F
32698	28	40	6.000	C-2F
32699	48	40	5.000	CC-2F

### Telefonlampe BPO 6x43mm

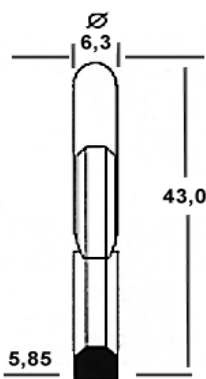

Bestell-Nr. Order-No.	Volt Volt	mA mA	Lebensdauer Life / h	Wendel Filament
32711	6	41	7.000	C-6
32712	12	20	5.000	CC-6
32713	17	45	5.000	C-2F
32714	24	100	5.000	C-2F
32715	45	35	5.000	CC-2F

# Telefonstecklampen

## Telephone lamps

### Telefonlampe T6,8K 7x22mm

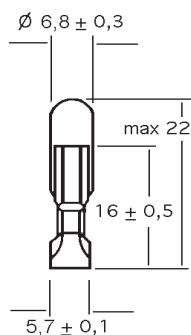

Bestell-Nr. Order-No.	Volt Volt	mA mA	Lebensdauer Life / h	Wendel Filament
32830	6	20	5.000	C-6
32831	6	40	5.000	C-6
32832	12	20	5.000	CC-6
32833	12	40	5.000	C-2F
32834	12	50	5.000	C-2F
32835	24	20	5.000	C-2F
32836	24	25	5.000	C-2F
32837	24	40	5.000	C-2F
32838	24	50	5.000	C-2F
32839	28	45	5.000	C-2F
32840	30	20	5.000	C-2F
32841	30	40	5.000	C-2F
32842	36	20	5.000	CC-2F
32843	48	20	5.000	CC-2F
32844	48	40	5.000	CC-2F
32845	48	50	5.000	CC-2F
32846	60	20	5.000	CC-2F
32847	60	40	5.000	CC-2F

### Telefonlampe F9 7x28mm

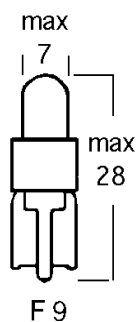

Bestell-Nr. Order-No.	Volt Volt	mA mA	Lebensdauer Life / h	Wendel Filament
32848	4	250	3.000	C-2R
31216	6	180	5.000	C-2V
31217	12	120	5.000	C-2V
32849	24	40	5.000	C-2V
25016	24	50	5.000	C-2F
31218	24	80	5.000	C-2F
32860	28	40	5.000	C-2F
32863	28	50	5.000	C-2F
32551	30	50	5.000	C-2F
32871	30	70	3.000	C-2F
32874	36	50	5.000	C-2F
32875	36	70	5.000	C-2F
32876	48	25	5.000	CC-2F
32877	48	50	2.500	CC-2F
31219	60	20	5.000	CC-2F

# Telefonlampen

## Telephone lamps

### Telefonlampe T 7x20mm, Sockel Ba7s

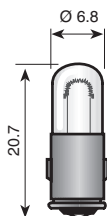

Bestell-Nr. Order-No.	Volt Volt	Watt Watt	mA mA	Lebensdauer Life / h	Wendel Filament
31311	6		20	2.000	C-2V
32122	6		40	2.000	C-2V
32123	6		50	2.000	C-2V
31312	6		80	2.000	C-2V
31301	6		100	2.000	C-2V
31313	6		180	2.000	C-2V
31302	6		200	2.000	C-2V
32124	6		333	2.000	C-2R
31314	7		80	2.000	C-2V
31303	7		100	2.000	C-2V
32125	12		20	2.000	C-2V
32126	12		50	2.000	C-2V
31304	12		100	2.000	C-2V
31315	12		120	2.000	C-2V
31316	12		165	2.000	C-2V
32129	14		80	2.000	C-2V
31317	14		100	2.000	C-2V
31321	24		20	2.000	C-2F
32127	24		25	2.000	C-2F
31305	24		50	2.000	C-2F
31322	24		60	2.000	C-2F
31323	24		80	2.000	C-2F
31324	24		100	2.000	C-2F
31306	24		125	2.000	C-2F
31325	24		170	2.000	C-2F
31326	28		20	2.000	C-2F
31327	28		25	2.000	C-2F
31307	28		40	2.000	C-2F
25009	28		60	2.000	C-2F
31328	28		70	2.000	C-2F
31329	28		100	2.000	C-2F
25012	30		20	2.000	C-2F
32132	30		40	2.000	C-2F
31308	30		50	2.000	C-2F
31330	30		60	2.000	C-2F
31331	30		70	2.000	C-2F
31332	30		100	2.000	C-2F
31333	36		20	2.000	C-2F
31334	36		40	2.000	C-2F
32135	36		50	2.000	C-2F
31335	48		20	2.000	C-2F
31336	48		25	2.000	C-2F
31337	48		30	2.000	C-2F
31338	48		40	2.000	C-2F
31339	48		50	2.000	C-2F
31309	60		20	2.000	C-2F
31341	60		25	2.000	C-2F
31342	60		50	2.000	CC-2F
31343	70		20	2.000	C-2F

# Telefonlampen

## Telephone lamps

### Telefonlampe T 7x23mm, Sockel Ba7s

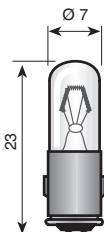

Bestell-Nr. Order-No.	Volt Volt	mA mA	Lebensdauer Life / h	Wendel Filament
25017	6	20	2.000	C-2V
32501	6	40	2.000	C-2V
31344	6	50	2.000	C-2V
31345	6	80	2.000	C-2V
31351	6	100	2.000	C-2V
31346	6	180	2.000	C-2V
31352	6	200	2.000	C-2R
31347	7	100	2.000	C-2V
31353	12	50	2.000	C-2V
31354	12	100	2.000	C-2V
31348	12	120	2.000	C-2V
31349	12	170	2.000	C-2V
31366	14	80	2.000	C-2V
31355	24	25	2.000	C-2F
31356	24	40	2.000	C-2F
31357	24	50	2.000	C-2F
31367	24	60	2.000	C-2F
31358	24	70	2.000	C-2F
31369	24	80	2.000	C-2F
31382	24	100	2.000	C-2F
31383	24	125	2.000	C-2F
31384	28	20	2.000	C-2F
31385	28	25	2.000	C-2F
31386	28	40	2.000	C-2F
31387	28	60	2.000	C-2F
31388	28	70	2.000	C-2F
31370	30	20	2.000	C-2F
31368	30	25	2.000	C-2F
31371	30	30	2.000	C-2F
31359	30	40	2.000	C-2F
31372	30	50	2.000	C-2F
31373	30	65	2.000	C-2F
31374	30	100	2.000	C-2F
31365	36	20	2.000	C-2F
31375	36	30	2.000	C-2F
32510	36	40	2.000	C-2F
31360	36	50	2.000	C-2F
31376	48	20	2.000	C-2F
31361	48	25	2.000	C-2F
31377	48	30	2.000	C-2F
31378	48	40	2.000	C-2F
31379	48	50	2.000	C-2F
31362	60	20	2.000	C-2F
31380	60	25	2.000	C-2F
32517	60	40	2.000	C-2F
31381	60	50	2.000	C-2F
31363	70	20	2.000	C-3A
32518	80	20	2.000	CC-2F

# Subminiaturlampen

## Subminiature lamps

### T1 3/4 5,7x16mm, Midget Grooved Socket S5,7S

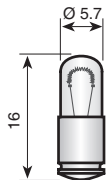

Bestell-Nr. Order-No.	US-Nr. US-No.	Volt Volt	mA mA	Lebensdauer Life / h	Wendel Filament
31433	698	1,35	60	3.000	C-6
31436	8699	2,5	200	3.000	C-6
31438	266	2,5	350	15.000	C-2R
31434	8704	2,7	60	6.000	C-6
31437	390	3	15	10.000	C-6
31440	7343	3	30	4.000	C-6
31441	7345	4,5	120	60.000	C-2R
31442	6950	5	17	2.000	C-6
31443		5	20	7.000	C-6
31444		5	30	10.000	C-6
31445		5	40	25.000	C-2R
31446	3152	5	60	6.000	C-6
31447	8705	6	40	25.000	C-2R
31448		6	100	45.000	C-2R
31449		6	125	5.000	C-2R
31460		6	180	18.000	C-2R
31401	337	6	200	2.000	C-2R
31462	7351	6,3	40	30.000	C-2R
31463	8708	6,3	75	8.000	C-2R
31464	7352	6,3	150	2.000	C-2R
31466	398	6,3	200	5.000	C-2R
31467	709	10	15	50.000	C-2F
31468	397	10	40	10.000	CC-2R
31469		12	20	7.000	C-2F
31470	7354	12	40	10.000	CC-2R
31471		12	60	16.000	C-2F
31472		12	75	10.000	C-2F
31402		12	100	8.000	C-2F
31473		12	120	10.000	C-2F
31474		14	50	15.000	C-2F
31403		14	80	15.000	C-2F
31475	393	14	100	10.000	C-2F
31476		16	30	15.000	C-2F
31413		18	40	10.000	C-2F
31477		19	40	15.000	C-2F
31478	457	22	40	3.000	C-2F
31479		24	20	8.000	C-2F
24672		24	25	12.000	CC-2F
31481		24	28	60.000	CC-2F
31482		24	35	10.000	C-2F
31483		24	40	7.000	C-2F
24673		24	50	2.000	C-2F
24674		24	80	8.000	C-2F

# Subminiaturlampen

## Subminiature lamps

### T1 3/4 5,7x16mm, Midget Grooved Socket S5,7S

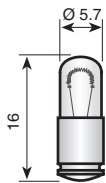

Bestell-Nr. Order-No.	US-Nr. US-No.	Volt Volt	mA mA	Lebensdauer Life / h	Wendel Filament
31484		28	24	6.000	CC-2F
31485		28	25	16.000	CC-2F
31486		28	30	6.000	C-2F
31487		28	35	15.000	C-2F
31404	334	28	40	5.000	C-2F
31488	334LSV	28	60	12.000	C-2F
31489	7356	28	65	6.000	C-2F
31490		28	80	6.000	C-2F
24478		32	33	3.000	CC-2F
31405		36	20	12.000	CC-2F
31406		36	40	3.000	C-2F
31407		48	20	4.000	CC-2F
31411		48	25	5.000	CC-2F
31492		48	30	2.500	CC-2F
31493		48	40	5.000	CC-2F
31408		60	20	5.000	CC-2F
31494		60	30	1.000	CC-2F



# Subminiaturlampen

## Subminiature lamps

### T1 3/4 5,7x16mm, Midget Flanged Socket SX6S

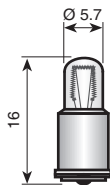

Bestell-Nr. Order-No.	US-Nr. US-No.	Volt Volt	mA mA	Lebensdauer Life / h	Wendel Filament
31521	331	1,35	60	3.000	C-6
31522	368	2,5	200	3.000	C-6
31523		2,5	300	3.000	C-6
31524	268	2,5	350	15.000	C-2R
31525	338	2,7	60	6.000	C-6
31526	375	3	15	10.000	C-6
31527	329	3	30	4.000	C-6
31529	7331	4,5	120	6.000	C-2R
31530	8950	5	17	2.000	C-6
31537		5	30	10.000	C-6
31540		5	40	25.000	C-2R
31541	3150	5	60	6.000	C-2R
31542		6	100	45.000	C-2R
31543		6	125	5.000	C-2R
31544		6	150	2.000	C-2R
31545		6	180	18.000	C-2R
31420	328	6	200	2.000	C-2R
31546	380	6,3	40	30.000	C-2R
31547	377	6,3	75	8.000	C-2R
31548	350	6,3	150	2.000	C-2R
31549	349	6,3	200	5.000	C-2R
31550	344	10	15	50.000	C-2F
31551	367	10	40	10.000	CC-2R
31552		12	20	7.000	C-2F
31553	394	12	40	1.000	CC-2R
31554		12	60	16.000	C-2F
31555		12	75	10.000	C-2F
31421		12	100	8.000	C-2F
31556		12	120	10.000	C-2F
31557		14	50	15.000	C-2F
31422		14	80	2.000	C-2F
31558		14	100	10.000	C-2F
31559		16	30	15.000	C-2F
31560	370	18	40	10.000	C-2F
31561		19	40	15.000	C-2F
31562		22	40	3.000	C-2F
31563		24	20	10.000	CC-2F
31564		24	25	12.000	CC-2F
31565		24	28	6.000	CC-2F
31566		24	35	10.000	C-2F
31567		24	40	7.000	C-2F
31568		24	50	12.000	CC-2F
31569		24	60	1.000	C-2F
31570		24	80	8.000	C-2F

# Subminiaturlampen

## Subminiature lamps

### T1 3/4 5,7x16mm, Midget Flanged Socket SX6S

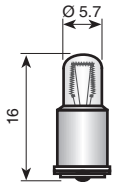

Bestell-Nr. Order-No.	US-Nr. US-No.	Volt Volt	mA mA	Lebensdauer Life / h	Wendel Filament
31571		28	24	6.000	CC-2F
31572		28	25	16.000	CC-2F
31573		28	30	6.000	C-2F
31574		28	35	15.000	C-2F
31423		28	40	30.000	C-2F
31575	376	28	60	12.000	C-2F
31576	7341	28	65	6.000	C-2F
31428		28	80	6.000	C-2F
31577		32	33	3.000	CC-2F
31424		36	20	12.000	CC-2F
31425		36	40	3.000	C-2F
31426		48	20	4.000	CC-2F
31578		48	25	5.000	CC-2F
31579		48	30	6.000	CC-2F
31580		48	40	5.000	CC-2F
31427		60	20	5.000	CC-2F
31581		60	30	1.000	CC-2F

# Subminiaturlampen

## Subminiature lamps

### E 5/8 T1 3/4 5,7x17,5mm, Midget Screw Socket

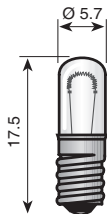

Bestell-Nr. Order-No.	US-Nr. US-No.	Volt Volt	mA mA	Lebensdauer Life / h	Wendel Filament
31582	8669	1,35	60	500	C-6
31583		1,5	75	30	C-2R
31458		1,5	100	1.000	C-2R
31461	7312	2,5	350	15.000	C-2R
31584		3	15	10.000	C-6
31585		4,5	60	1.000	C-2R
31586	7318	5	60	25.000	C-2R
31587	7319	5	115	4.000	C-2R
31459	342	6	40	5.000	C-2V
31588		6	60	5.000	C-2R
31589		6	100	10.000	C-2V
31450	1768	6	200	1.000	C-2R
31590		6,3	60	1.000	C-2R
31591		6,3	200	5.000	C-2R
31592		6,5	150	1.000	C-2R
31593	8691	10	15	10.000	C-2F
31594	389	10	40	1.000	C-2R
31595		12	40	5.000	C-2F
31596		12	50	2.000	C-2V
31597		12	60	5.000	C-2V
31598		12	80	5.000	C-2V
31451		12	100	10.000	C-2V
31599		12	120	1.000	C-2V
31600		14	40	5.000	C-2F
31604		14	50	1.000	C-2F
31452	373	14	80	2.500	C-2F
31605		14	100	1.000	C-2F
31607		18	40	5.000	C-2F
31608		24	20	8.000	C-2F
31609		24	35	25.000	C-2F
31617		24	40	10.000	C-2F
31618		24	50	1.000	C-2F
31625		24	60	1.000	C-2F
31412		24	80	5.000	C-2F
31626		28	25	15.000	CC-2F
31453	399	28	40	7.000	C-2F
31627	335LSV	28	60	25.000	C-2F
31630		28	80	6.000	C-2F
31454		36	20	1.000	C-2F
31455		36	40	2.000	C-2F
31456		48	20	4.000	CC-2F
31457		60	20	5.000	CC-2F

### T1 USA MF, Midget Flanged Socket (R3/9)

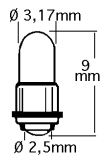

Bestell-Nr. Order-No.	Type-Nr. Type-No.	Volt Volt	mA mA	Lebensdauer Life / h	Wendel Filament
24445	3007	5	40	50.000	C-2R
24446	685	5	60	25.000	C-2R
24447	718	5	115	40.000	C-2R
24448		6	40	10.000	C-2V
24450		6	70	15.000	C-2V
24451		12	30	15.000	C-2V
24452		12	60	15.000	C-2V
24453	8112	14	65	16.000	C-2F
24454	7241	18	26	16.000	C-2F
24456		24	20	20.000	CC-2F
24440	6839	28	24	16.000	CC-2F

### T1 French MF, Midget Flanged Socket (R3/14)

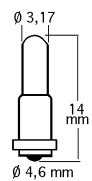

Bestell-Nr. Order-No.	Type-Nr. Type-No.	Volt Volt	mA mA	Lebensdauer Life / h	Wendel Filament
24457		6	200	1.000	C-2V
24458		12	40	10.000	C-2F
24459		12	100	1.000	C-2F
24460		24	20	15.000	CC-2F
24461		28	40	1.000	C-2F

### MS 2/8

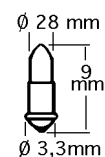

Bestell-Nr. Order-No.	Type-Nr. Type-No.	Volt Volt	mA mA	Lebensdauer Life / h	Wendel Filament
24431	MS2200	2	50	1.000	C-2R
24432	MS2500	6	50	5.000	C-2V
24430	MS2900	12	50	5.000	C-2V
24434	MS3400	24	20	5.000	CC-2V
24438	MS3500	28	20	5.000	CC-2V

### MS 4

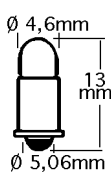

Bestell-Nr. Order-No.	Type-Nr. Type-No.	Volt Volt	mA mA	Lebensdauer Life / h	Wendel Filament
24462	MS8660	6	40	1.000	C-2V
24463	MS662	12	50	25.000	C-2F
24464	MS670	24	35	25.000	C-2F
24442	MS8632	28	40	1.000	C-2F
24465	MS624	48	25	1.000	CC-2F

### Bi-Pin T1 3,2x9,5mm, Pin Abstand 1,27

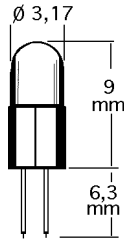

Bestell-Nr. Order-No.	US-Nr. US-No.	Volt Volt	mA mA	Lebensdauer Life / h	Wendel Filament
24487		2,5	200	600	C-2R
24480	7685BP	5	60	25.000	C-2R
24481	7714BP	5	75	60.000	C-2R
24482	7715BP	5	115	40.000	C-2R
24483		6	60	5.000	C-2R
24486		12	30	10.000	C-2F
24484	8097BP	12	60	16.000	C-2V
24488		14	65	16.000	C-2F
24485	7839BP	28	24	16.000	CC-2F
24492		28	40	10.000	C-2F

### Bi-Pin T1 3,2x9,5mm, Pin Abstand 2,54

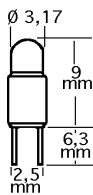

Bestell-Nr. Order-No.	Volt Volt	mA mA	Lebensdauer Life / h	Wendel Filament
24390	5	60	25.000	C-2R
24391	6	115	40.000	C-2R
24394	12	50	10.000	C-2V
24392	12	60	16.000	C-2F
24399	18	26	16.000	C-2F
24423	24	24	16.000	CC-2F
24424	28	24	16.000	CC-2F
24393	28	40	1.000	CC-2F
24395	30	20	5.000	CC-2F
24694	36	20	10.000	CC-2F

### Bi-Pin T1 3,2x10mm, Pin Abstand 3,17

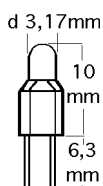

Bestell-Nr. Order-No.	Volt Volt	mA mA	Lebensdauer Life / h	Wendel Filament
24572	5	60	25.000	C-2R
24571	5	75	25.000	C-2R
24577	12	40	10.000	C-2V
24573	12	60	1.600	C-2V
24578	18	26	1.600	CC-2F
24579	24	20	1.600	CC-2F
24574	28	24	1.600	CC-2F

# Subminiaturlampen

## Subminiature lamps

### Bi-Pin T1 1/4 4,5x16mm, Pin Abstand 2,54



Bestell-Nr. Order-No.	US-Nr. US-No.	Volt Volt	mA mA	Lebensdauer Life / h	Wendel Filament
24437	7583	5	60	25.000	C-2R
24426	7309	6	60	3.000	C-2R
24411		6	200	5.000	C-2R
24428		12	40	10.000	C-2V
24425		12	50	10.000	C-2V
24413	7646	14	80	1.000	C-2F
24433		16	30	10.000	C-2F
24402		24	35	25.000	C-2F
24419	7632	28	40	4.000	C-2V
24455		36	20	5.000	CC-2F
24470		48	25	5.000	CC-2F
24405		60	20	5.000	CC-2F

### Bi-Pin T1 1/4 5,7x16mm, Pin Abstand 3,17

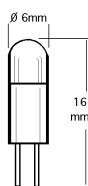

Bestell-Nr. Order-No.	US-Nr. US-No.	Volt Volt	mA mA	Lebensdauer Life / h	Wendel Filament
24493	7968	2,5	200	3.000	C-2R
24494	7375	3	15	10.000	C-6
24466	7361	5	60	25.000	C-2R
24495	7945	6	40	10.000	C-2V
24467	7328	6	200	1.000	C-2R
24496	7380	6,3	40	10.000	C-2V
24497	7377	6,3	75	3.000	C-2V
24498	7367	10	40	5.000	C-2F
24439	7371	12	40	10.000	C-2F
24468		12	60	10.000	C-2V
24469	7382	14	80	15.000	C-2F
24500	7370	18	40	10.000	C-2F
24410	7387	28	40	7.000	C-2F
24471		48	25	5.000	CC-2F

# Subminiaturlampen

## Subminiature lamps

### Wedge Base T10 10x28mm, W2,1x9,5D

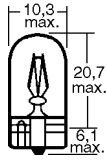

Bestell-Nr. Order-No.	Volt Volt	Watt Watt	mA mA	Lebensdauer Life / h	Wendel Filament
24032	6,3	1	150	10.000	C-2V
24049	6,3	1,6	250	10.000	C-2V
24050	6,3	3,1	500	5.000	C-2V
24051	12	1,2	100	5.000	C-2V
24052	12	1,5	125	5.000	C-2V
24053	12	2	165	2.000	C-2V
24054	12	2,2	183	1.000	C-2V
24055	12	3	250	5.000	C-2V
24056	12	5	400	2.000	C-2V
24057	14	3,4	240	500	C-2V
24058	14	3,8	270	1.500	C-2F
24062	24	2	80	5.000	C-2F
24063	24	3	125	5.000	C-2F
24064	24	5	208	500	C-2F
24067	28	1,7	60	10.000	C-2F
24068	48-60	2	40	2.000	C-2F

### Wedge Base T10 10x28mm, W2,1x9,5D

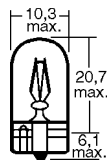

Bestell-Nr. Order-No.	Type-Nr. Type-No.	Volt Volt	Watt Watt	mA mA	Lebensdauer Life / h
24035	klar	12-15	2	170	2.000
24036	klar	24-30	2	80	2.000
24034	matt	6-7	2		
24033	matt	12-15	2	170	2.000

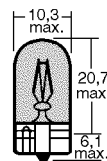

### Wedge Base T5 5x20mm, W2x4,6D

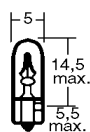

Bestell-Nr. Order-No.	Volt Volt	mA mA	Lebensdauer Life / h	Wendel Filament
24070	6	30	5.000	C-2V
24071	6	80	1.000	C-2V
24072	6	150	2.000	C-2R
24073	6	200	2.000	C-2R
24074	6,3	40	10.000	C-2V
24075	12	30	5.000	C-2V
24076	12	80	10.000	C-2V
24077	12	100	10.000	C-2V
24078	12	165	1.000	C-2V
24079	24	30	5.000	C-2F
24084	24	40	10.000	C-2F
24085	24	50	1.000	C-2F
24086	28	40	10.000	C-2F

# Subminiaturlampen

## Subminiature lamps

### Wedge Base T5 5x20mm, W2,4x6D

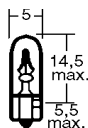

Bestell-Nr. Order-No.	Type-Nr. Type-No.	Volt Volt	mA mA	Watt Watt
24028	2322 klar	12-15	30	
24030	2342 klar	24-30	30	
24024	2305 klar	6-7		1W
24027	2321 klar	12-15		1W
24029	2341 klar	24-30		1W

### T1 freie Stomzuführung (Wire Ended) 3,2x6,35mm

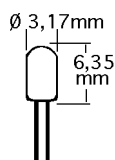

Bestell-Nr. Order-No.	US-Nr. US-No.	Volt Volt	mA mA	Lebensdauer Life / h	Wendel Filament
24501	7205	3	15	5.000	C-2R
24507	6022	5	21	10.000	C-2R
24510	7210	5	30	25.000	C-2R
24509	680	5	60	60.000	C-2R
24550	713	5	75	25.000	C-2R
24551	715	5	115	4.000	C-2R
24511	7216	5	125	10.000	C-2R
24552		6	50	15.000	C-2V
24513		6	60	10.000	C-2R
24515		6	70	10.000	C-2R
24521	7218	10	27	10.000	C-2V
24554		12	30	5.000	C-2V
24522		12	40	10.000	C-2V
24526		12	50	10.000	C-2V
24503	7219	12	60	16.000	C-2V
24557		14	40	10.000	C-2F
24548	8111	14	65	16.000	C-2F
24549		14	80	10.000	C-2F
24555	7220	18	26	16.000	C-2F
24556		24	20	5.000	CC-2F
24542	6838	28	24	16.000	CC-2F

### Lampenziher



Bestell-Nr. Order-No.	für Sockel for Base
26108	F9
26102	T4,5 + T4,6
26104	T5,5 + T5,5k + W2x4,6d
26106	T6,8
26112	E10 + Ba9s
26114	E14 + Ba15d
26116	E14 + Ba15d



# Subminiaturlampen

## Subminiature lamps

### T1 1/4 freie Stromzuführung (Wire Ended) 4,5x11,7mm

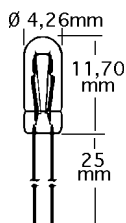

Bestell-Nr. Order-No.	US-Nr. US-No.	Volt Volt	mA mA	Lebensdauer Life / h	Wendel Filament
24560	2135	1,3	30	100	S-2
24561	749	1,5	70	25.000	C-2R
24600	324	3	190	350	C-2R
24563		4,5	40	10.000	C-2R
24566		4,5	60	5.000	C-2R
24517	583	5	60	25.000	C-2R
24519	515	5	115	40.000	C-2R
24569	8661	6	40	10.000	C-2V
24580	2114	6	60	3.000	C-2R
24581		6	100	6.000	C-2R
24537	634	6	200	1.000	C-2R
24582	8610	6,3	200	5.000	C-2R
24583	8608	10	15	10.000	C-2F
24543	772	12	35	25.000	C-2F
24584		12	40	10.000	C-2V
24585	753	12	60	15.000	C-2F
24586	754	12	80	1.000	C-2V
24587		12	100	1.000	C-2V
24588	8640	14	80	1.000	C-2F
24589		24	35	25.000	C-2F
24590		28	25	5.000	C-2F
24591	8627	28	40	1.000	C-2F
24592		48	25	1.000	CC-2F

### T1 3/4 freie Stromzuführung (Wire Ended) 5,7x13,2mm

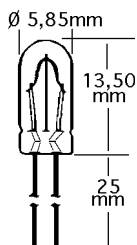

24593	2169	2,5	350	10.000	C-2R
24594	2158	3	15	10.000	C-2R
24595		5	15	10.000	C-2V
24562	2200	5	60	25.000	C-2R
24564	1730	6	40	10.000	C-2V
24596		6	100	10.000	C-2V
24565	1784	6	200	1.000	C-2R
24597	2180	6,3	40	10.000	C-2V
24598	1739	6,3	75	500	C-2R
24599	2181	6,3	200	20.000	C-2F
24604	1869	10	15	10.000	C-2F
24567	2174	12	40	10.000	C-2F
24615		12	60	10.000	C-2V
24568	2182	14	80	15.000	C-2F
24616		24	40	5.000	C-2F
24531	2176	24	50	2.000	C-2F
24619		28	24	10.000	C-2F
24659	2185	28	40	10.000	C-2F
24622		48	20	5.000	CC-2F
24631		60	20	5.000	CC-2F

# Soffittenlampen

## Festoon lamps

### Soffittenlampen S6 6x24mm

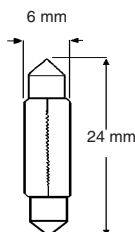

Bestell-Nr. Order-No.	Volt Volt	Watt Watt	mA mA	Lebensdauer Life / h	Wendel Filament
32300	6	0,3	50	2000	C-6
32301	6	1	165	2000	C-6
32303	9	0,45	50	2000	C-6
31601	12	1,2	100	2000	C-6
32302	12	2	165	2000	C-6
32304	24	1,2	50	2000	C-6
31603	24	3	125	2000	C-6
31602	26	1	40	2000	C-6
32305	28	2	70	2000	C-6
32309	36	1,5	40	2000	C-6
32311	48	1,2	25	2000	C-6

### Soffittenlampen S6 6x28mm

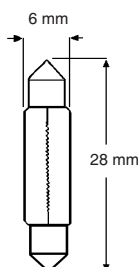

Bestell-Nr. Order-No.	Volt Volt	Watt Watt	mA mA	Lebensdauer Life / h	Wendel Filament
32312	6	1,2	200	2000	C-6
32306	6	3	500	2000	C-6
31606	12	1,2	100	2000	C-6
32313	12	3	250	2000	C-6
32315	24	3	125	2000	C-6
32317	26	2,9	110	2000	C-6
32318	50	2,5	50	2000	C-6

### Soffittenlampen S6 6x31mm

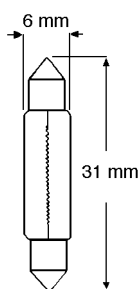

Bestell-Nr. Order-No.	Volt Volt	Watt Watt	mA mA	Lebensdauer Life / h	Wendel Filament
32321	6	0,3	50	2000	C-6
31611	6	3	500	2000	C-6
32322	12	2	166	2000	C-6
31612	12	3	250	2000	C-6
32323	24	1,2	50	2000	C-6
32324	24	1,5	62	2000	C-6
31613	24	3	125	2000	C-6
32325	30	1,5	50	2000	C-6
32329	48	3	62	2000	C-6

# Soffittenlampen

## Festoon lamps

### Soffittenlampen S6 6x36mm

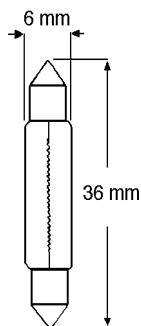

Bestell-Nr. Order-No.	Volt Volt	Watt Watt	mA mA	Lebensdauer Life / h	Wendel Filament
31621	6	3	500	2000	C-6
32334	12	3	250	2000	C-6
32336	24	1,2	50	2000	C-6
32339	24	2	80	2000	C-6
31623	24	3	125	2000	C-6
31624	30	3	100	2000	C-6
32344	48	3	60	2000	C-6
32349	60	3	50	2000	C-6

### Soffittenlampen S6 6x39mm

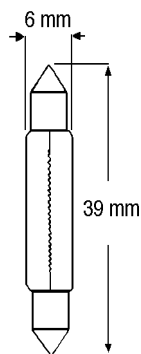

Bestell-Nr. Order-No.	Volt Volt	Watt Watt	mA mA	Lebensdauer Life / h	Wendel Filament
32320	6	3	500	2000	C-6
31631	12	1,2	100	2000	C-6
32352	12	3	250	2000	C-6
32353	24	1,2	50	2000	C-6
32354	24	2	80	2000	C-6
31632	24	3	125	2000	C-6
32355	28	2	70	2000	C-6
31633	36	3	83	2000	C-6
32364	48	3	60	2000	C-6
32370	60	3	50	2000	C-6

### Soffittenlampen S7 8x28mm

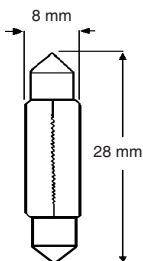

Bestell-Nr. Order-No.	Volt Volt	Watt Watt	mA mA	Lebensdauer Life / h	Wendel Filament
32371	12	2	166	2000	C-6
32383	12	3	250	2000	C-6
32385	24	3	125	2000	C-6
32387	24	5	210	2000	C-6

# Soffittenlampen

## Festoon lamps

### Soffittenlampen S7 8x31mm

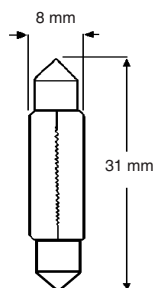

Bestell-Nr. Order-No.	Volt Volt	Watt Watt	mA mA	Lebensdauer Life / h	Wendel Filament
31641	6	3	500	2000	C-6
31649	6	5	830	2000	C-6
31642	12	3	250	2000	C-6
32389	12	5	410	2000	C-6
32399	24	2	80	2000	C-6
31643	24	3	125	2000	C-6
31646	24	5	210	2000	C-6
32412	30	3	100	2000	C-6
31644	30	5	167	2000	C-6
31645	36	3	83	2000	C-6
32413	48	3	65	2000	C-6
32414	48	5	105	2000	C-6
32419	60	3	50	2000	C-6
32420	60	5	85	2000	C-6

### Soffittenlampen S7 8x36mm

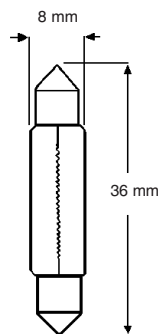

Bestell-Nr. Order-No.	Volt Volt	Watt Watt	mA mA	Lebensdauer Life / h	Wendel Filament
32333	6	3	500	2000	C-6
32421	6	5	835	2000	C-6
31701	12	3	250	2000	C-6
32422	12	5	500	2000	C-6
32338	24	2	80	2000	C-6
31702	24	3	125	2000	C-6
32423	24	5	208	2000	C-6
32424	48	3	60	2000	C-6
32428	60	3	50	2000	C-6

### Soffittenlampen S7 8x39mm

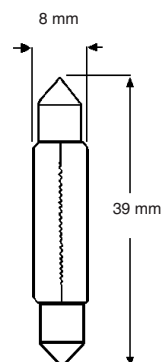

Bestell-Nr. Order-No.	Volt Volt	Watt Watt	mA mA	Lebensdauer Life / h	Wendel Filament
32340	6	3	500	2000	C-6
32425	6	5	833	2000	C-6
31711	12	3	250	2000	C-6
31708	12	5	420	2000	C-6
31712	24	3	125	2000	C-6
31713	24	5	210	2000	C-6
31714	30	3	100	2000	C-6
32426	36	1,44	40	2000	C-6
32427	48	5	104	2000	C-6

# Soffittenlampen

## Festoon lamps

### Soffittenlampen S8,5 11x39mm

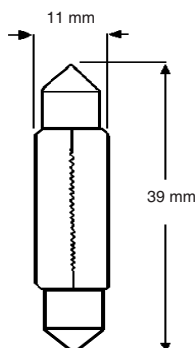

Bestell-Nr. Order-No.	Volt Volt	Watt Watt	mA mA	Lebensdauer Life / h	Wendel Filament
31734	6	0,3	50	2000	C-6
31735	6	1,2	200	2000	C-6
31721	6	3	500	2000	C-6
32347	6	5	830	2000	C-6
31736	12	0,6	50	2000	C-6
31737	12	1,2	100	2000	C-6
31722	12	3	250	2000	C-6
31723	12	5	416	2000	C-6
31738	12	10	830	2000	C-6
31739	24	1,2	50	2000	C-6
31724	24	3	125	2000	C-6
31725	24	5	208	2000	C-6
32362	24	10	416	2000	C-6
31726	30	3	100	2000	C-6
31727	30	5	167	2000	C-6
31728	48	3	60	2000	C-6
31742	48	5	100	2000	C-6
31729	60	3	50	2000	C-6
31730	60	5	80	2000	C-6

### Soffittenlampen S8,5 11x43mm

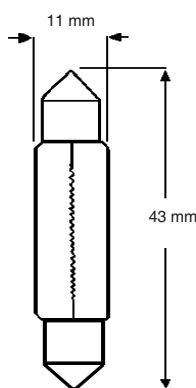

Bestell-Nr. Order-No.	Volt Volt	Watt Watt	mA mA	Lebensdauer Life / h	Wendel Filament
31743	6	3	500	2000	C-6
32386	6	5	830	2000	C-6
31801	12	3	250	2000	C-6
32367	12	5	415	2000	C-6
31744	12	10	830	2000	C-6
31745	12	15	1250	2000	C-6
31802	24	2	80	2000	C-6
32372	24	3	125	2000	C-6
31803	24	5	210	2000	C-6
32380	24	10	415	2000	C-6
31804	30	3	100	2000	C-6
31746	48	3	62	2000	C-6
32384	48	5	100	2000	C-6
31805	60	3	50	2000	C-6
31806	60	5	80	2000	C-6

# Soffittenlampen

## Festoon lamps

### Soffittenlampen S8,5 15x43mm

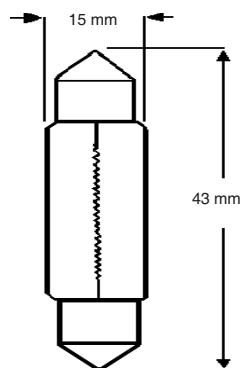

Bestell-Nr. Order-No.	Volt Volt	Watt Watt	mA mA	Lebensdauer Life / h	Wendel Filament
31807	6	5	C-6	2000	830 C-6
31747	6	10	C-6	2000	1,6A C-6
31748	6	15	C-6	2000	2,5A C-6
10192	6	18	C-6	2000	3A C-6
31749	12	3	C-6	2000	250 C-6
31808	12	5	C-6	2000	415 C-6
32390	12	10	C-6	2000	830 C-6
32391	12	15	C-6	2000	1,25A C-6
31750	12	18	C-6	2000	1,5A C-6
32392	24	3	C-6	2000	125 C-6
31810	24	5	C-6	2000	210 C-6
31811	24	10	C-6	2000	415 C-6
31751	24	18	C-6	2000	750 C-6
31812	30	5	C-6	2000	167 C-6
31815	30	10	C-6	2000	333 C-6
31819	48	5	C-6	2000	100 C-6
31752	48	10	C-6	2000	210 C-6
32400	60	3	C-6	2000	50 C-6
31813	60	5	C-6	2000	80 C-6
31800	60	10	C-6	2000	160 C-6
31753	72	5	C-6	2000	70 C-6
31754	80	5	C-6	2000	60 C-6

### Soffittenlampen SF6 (S6 mit Kappen) 6,4x30mm (Fuselamp)

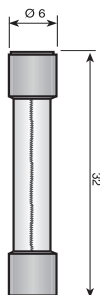

Bestell-Nr. Order-No.	Volt Volt	Watt Watt	mA mA	Lebensdauer Life / h	Wendel Filament
31760	6	0,6	100	3000	C-6
31761	6,3	0,94	150	3000	C-6
31762	8	2,4	300	3000	C-6
31763	12	1,3	110	3000	C-6
31764	12	1,8	150	3000	C-6
31765	12	3,6	300	3000	C-6

# Lampensockel

## Lampbases

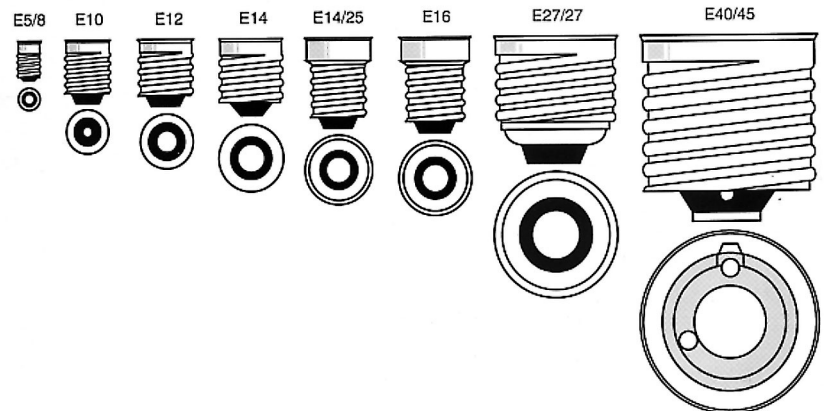
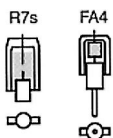
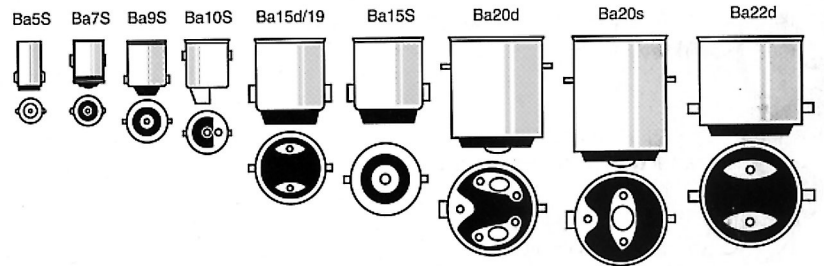
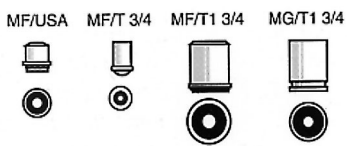
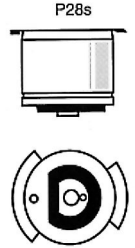
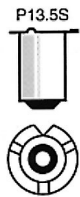
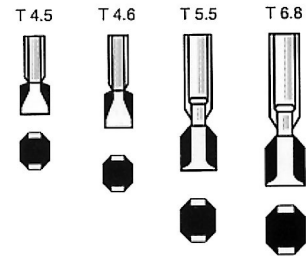
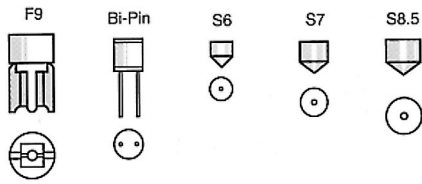
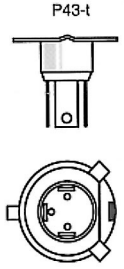
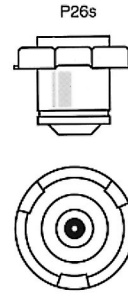
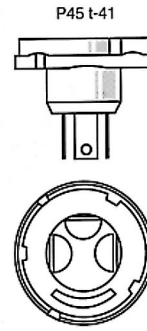
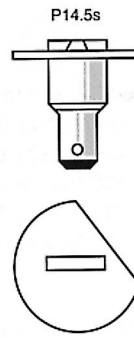
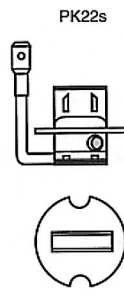

# Wendelformen

## Filaments

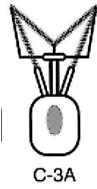
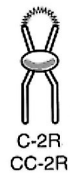
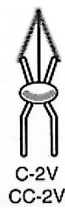

### Hinweise zur Lebensdauer von Leuchtmitteln:

Die angegebenen Werte für die Lebensdauer stellen immer einen mittleren Wert dar, der aus einer großen Anzahl von mit Nennspannung durchgeführten Tests abgeleitet wurde. Kriterien die zu einer Verkürzung der Lebensdauer führen, sind z.B. eine Erhöhung der Betriebsspannung (bei nur 5% verringert sich die Lebensdauer um bis zu 50%). Häufiges Ein- und Ausschalten der Lampe verringert ebenfalls ihre Lebensdauer.



HANS RAUM GMBH  
Postfach 3845  
  
90019 Nürnberg

\_\_\_\_\_ Firma: \_\_\_\_\_ company:  
\_\_\_\_\_ Branche: \_\_\_\_\_ industrial sector:  
\_\_\_\_\_ Abteilung: \_\_\_\_\_ department:  
\_\_\_\_\_ Strasse : \_\_\_\_\_ road:  
\_\_\_\_\_ Plz / Ort : \_\_\_\_\_ postcode / place:  
\_\_\_\_\_ Telefon : \_\_\_\_\_ telephone:  
\_\_\_\_\_ Telefax : \_\_\_\_\_ telefax:  
\_\_\_\_\_ Ansprechpartner : \_\_\_\_\_ person to turn to:

**Kataloganforderung unter:**  
**Fax: (+49) 0911 96 280 -55**

for your fax-order:  
(+49) 0911 96 280-55:

**Wenn Sie unsere neuesten Kataloge wünschen, bitte ankreuzen und zifaxen.**  
please, mark with a cross your catalog order.

- Anzeige- und Signallampen
- Fahrzeuglampen
- Allgebrauchslampen
- Leuchtstofflampen
- Halogenlampen
- Kompaktleuchtstofflampen + Energiesparlampen
- Entladungslampen
- Fotolampen, Studio, Bühne, TV
- medizinisch- wissenschaftliche Lampen
- Weihnachtsbeleuchtung
- Technische Leuchten
- Vorschaltgeräte
  
- Gesamt-Unterlagen

Besuchen sie unsere Homepage!

Unter: <http://www.lampen-raum.de> können Sie unsere Kataloge einsehen, und ggf. die gewünschten Seiten ausdrucken.

Sollten Sie ein Leuchtmittel benötigen, daß Sie im Katalog nicht finden können, brauchen Sie nur die Ihnen bekannten Daten in der Seite "**SUCHEN**" einzutragen und per e-Mail: an [verkauf@lampen-raum.de](mailto:verkauf@lampen-raum.de) zu senden. Wir ermitteln für Sie das gewünschte Leuchtmittel und senden Ihnen unser Angebot.

HANS RAUM GMBH  
 Postfach 3845  
  
 90019 Nürnberg

Firma: \_\_\_\_\_ company:  
 Branche: \_\_\_\_\_ industrial sector:  
 Abteilung: \_\_\_\_\_ department:  
 Strasse: \_\_\_\_\_  
 PLZ / Ort: \_\_\_\_\_ postcode / place:  
 Telefon: \_\_\_\_\_ telephone:  
 Telefax: \_\_\_\_\_ telefax:  
 Ansprechpartner: \_\_\_\_\_ person to turn to:

**Kopiervorlage für Ihre FAX-Bestellung unter: (+49) 0911 96 280 -55**

Pos.	Bestell-Nummer part number	Artikelbezeichnung / marking	Menge quantity	Einzelpreis single price
1				
2				
3				
4				
5				
6				
7				
8				
9				
10				
11				
12				

Datum / Unterschrift / Firmenstempel

date /

## VERKAUFS- und LIEFERBEDINGUNGEN

**gültig für alle Verkäufe, sofern nicht ausdrücklich für einzelne Lieferungen andere Abmachungen schriftlich getroffen sind.**

1. Die Berechnung erfolgt in Euro zu den am Tage der Bestätigung geltenden Listenpreisen und Bedingungen. Vereinbarte Preise können jedoch erhöht werden, falls bis zum Tage der Lieferung die zur Zeit des Vertragsabschlusses geltenden Rohstoffpreise erhöht oder Lohnerhöhungen vereinbart werden.
2. Die Lieferung erfolgt auf Gefahr des Bestellers; eine Transportversicherung wird von uns nicht gedeckt. Preise verstehen sich ab Lager Nürnberg. Bei einem Netto-Warenwert ab € 300,- erfolgt Lieferung frei Haus (in Deutschland).  
**Werden vom Kunden Expreßlieferungen gewünscht, gehen die Expreßkosten grundsätzlich zu Lasten des Empfängers.**
3. Als Zahlungsziel wird äußerst eine Frist von 30 Tagen ab Rechnungsdatum eingeräumt; die Preise gelten netto Kasse. Bei Versand gegen Nachnahme und Regulierung innerhalb 8 Tagen nach Rechnungsdatum gewähren wir 2% Skonto. Bei Wechselzahlungen wird kein Skonto gewährt; Wechselsteuer und sonstige Auslagen gehen zu Lasten des Kunden.
4. Die gelieferten Waren bleiben bis zur völligen Bezahlung unser Eigentum. Der Käufer kann die Waren im Rahmen eines ordnungsgemäßen Geschäftsbetriebes veräußern oder weiterverarbeiten. Jede Verpfändung oder Sicherungsübereignung zugunsten Dritter ist unzulässig, evtl. Pfändung durch Dritte ist uns sofort bekanntzugeben. Bei Weiterverkauf der Waren geht die jeweils entstehende Forderung an die einzelnen Kunden ohne weiteres auf uns über. Gerät der Verkäufer in Verzug, so können wir Rückgabe der Ware verlangen, ohne das wir vom Vertrag zurücktreten.
5. Reklamationen können nur innerhalb 8 Tagen nach Lieferung berücksichtigt werden und auch nur soweit, wie die beanstandeten Lampen frei zurückgesandt werden. Wenn die Prüfung ergibt, daß Fabrikations- oder Materialfehler vorliegen, wird nach unserem Ermessen Ersatz geleistet oder Gutschrift erteilt.

**Wenn an den Lampen Veränderungen vorgenommen worden sind oder die Fehler und Beschädigungen aufgrund fahrlässiger und unsachgemäßer Behandlung durch den Empfänger oder seine Beschäftigten entstanden, können Reklamationen grundsätzlich nicht mehr anerkannt werden.**

6. Liefertermine werden bestmöglich eingehalten. Für Lieferungsverzögerungen oder -beschränkungen, die durch höhere Gewalt, Streik, Betriebsstörung, Strom- und Gasausfall usw. überhaupt ohne unser Verschulden entstehen, übernehmen wir keine Verantwortung; sie berechtigen den Besteller nicht, erteilte Aufträge zurückzuziehen oder Schadensersatzansprüche irgendwelcher Art zu stellen.
7. Änderungen der Konstruktion, Abmessungen und Bezeichnungen bleiben vorbehalten. Mehr- oder Minderlieferungen bis zu 20% bei Kleinaufträgen und Sonderanfertigungen, die nach Angaben und im Rahmen der techn. Möglichkeiten hergestellt sind, können vom Besteller nicht beanstandet und müssen abgenommen werden .
8. Bedingungen, die Auftraggeber auf ihren Anfragen oder Bestellungen vorgedruckt oder sonstwie erwähnt haben, erkennen wir, sofern diese in Widerspruch zu unseren Verkaufs- und Lieferungsbedingungen stehen, nicht an, auch wenn wir den selben im einzelnen nicht widersprochen haben. Irgendwelche Abweichungen von vorstehenden Bedingungen sind vielmehr nur dann wirksam, wenn sie ausdrücklich schriftlich bestätigt sind.
9. Im übrigen gelten die allgem. Lieferbedingungen des Elektrogroßhandels in ihrer gegenwärtigen Form.
10. Durch Erteilung von Aufträgen, erklärt der Besteller sein Einverständnis mit vorstehenden Bedingungen.

**Preise:** Genannte Preise sind Netto-Stückpreise (bezogen auf den Zeitpunkt der Drucklegung dieses Kataloges) per Stück gem. Abnahmemenge, auch bei sortierter Abnahme, zuzüglich ges. MwSt. **Sonderkonditionen:** Bei Großabnahme auf Anfrage.

**Lieferung:** Zu unseren Lieferungs- und Zahlungsbedingungen, ab € 300,00 frei Haus (in Deutschland).

**Zahlung:** Innerhalb von 8 Tagen 2% Skonto oder 30 Tage netto. Aufträge unter € 50,00 Warenwert werden mit €10,00 Mindermengenzuschlag abgerechnet. **Angebote:** Alle Angebote sind freibleibend.

**Druckfehler, Irrtum und Änderungen bleiben vorbehalten. Nachdruck auch Auszugsweise verboten. Gerichtsstand Nürnberg.**

# RAUM

DER LAMPEN-SPEZIALIST  
HANS RAUM GmbH

## HANS RAUM GMBH

Postfach 3845 · 90019 Nürnberg  
Wertachstr. 29 - 31 · 90451 Nürnberg  
Telefon (+49) 0911 96 280 -0  
Telefax (+49) 0911 96 280 55

Internet: <http://www.lampen-raum.de>  
E-Mail: [verkauf@lampen-raum.de](mailto:verkauf@lampen-raum.de)

## HANS RAUM GMBH Niederlassung München

Wilhelm-Riehl-Str. 11 · 80687 München  
Telefon (+49) 089 517 3989 -0  
Telefax (+49) 089 517 3989 -15

Internet: <http://www.lampen-raum.de>  
E-Mail: [verkaufmuenchen@lampen-raum.de](mailto:verkaufmuenchen@lampen-raum.de)

Lg: 1 3 13 02 520

